

CHEVY

Truck

BRAKES

Bearing Kit	15
Big Brake Kits	
Complete Front/Rear Big Brake Kits.....	5
Rear	5
Wheel Kits.....	5
Complete Front & Rear Disc Brake Kits	6
Brake Boosters	
Firewall Kit	16
Frame Mount Kit	16
OEM Replacement.....	18



Page 14

Brake Line Kits	15
Brake Pedal Brackets	19
Booster Clevis	18
Brake Pedal Brackets	19
Disc Bracket Kit	
Dust Shields	15
Firewall & Booster Boot	18
Front Brake Kits	
CPP Complete Brake Kits.....	6-8
Baer Pro+ System	10
Baer Extreme+ System	10
Modular™ Drop Spindle, Complete	6
Hydraulic Assist Systems	
Accessories.....	17
Bare Units	17
Hydra Stop™ Show Stopper™	17
Hydra Stop™ Street Beast™	17

Master Cylinders	
MINI™ Disc Kits	14
Rear Axle Flex Hose	12
Rear Brake Kits	
9" Ford Flange	12
Baer SS4+ Systems.....	12
Large GM Flange	11
Rear Disc Emergency Brake Cables	15
Roller Bearing Kit	15
Spindles	
Modular™ Drop Spindles.....	14
C10 Disc Brake Spindles.....	14
Drop Spindles	14
Spindle Brake Components & Kits	15
Wheel Brake Kits	
Modular™ Drop Spindle	7
OE Drop Spindle.....	7
OE Stock Spindle	9
Stock Height 5-Lug	9
Stock Height 6-Lug	9
Upgrade Drop Spindle.....	7
Upgrade Stock Spindle	9
Wilwood, Front	10
Wilwood, Rear	13

SUSPENSION

Air Suspension Systems	27
Ball Joints	38
Blocks with 4° Built-in Shims	37
Block Kits & U-Bolts, Rear Lowering	37



Page 37

Body Mount Bushing Kit	41
Bump Stops	45
Bushings	45
C-Notch Kit	43
Carrier Bearing Bracket	43
Carrier Bearing Conversion Kit	46
Chassis	
Basic Upgrade	24
Coil Spring Front End IFS.....	25
Custom, IFS.....	25
Upgrade Kit Deluxe	21
TCI Complete or Base	23
TCI Basic or Deluxe.....	24
TCI Components.....	22
Coil Springs	33



Page 31

Coil Spring Retainers	33
Coil Spring Stock/Drop Kits	32
Coil Spring & Shock Kit	31
Complete Performance Package	31
Control Arms	
Stock-Type	35
Totally Tubular™.....	34
Control Arm Bushings	38
Control Arm Cross Shaft Kits, Upper & Lower ..	38
Crossmembers	
Drop Center	43
Crossmembers	20
Tubular Replacement Rear Shock	45

Custom IFS..... 25

Drag Link

Repair Kit..... 41

1/2, 3/4 & 1 Ton..... 41

Drop Axle, Front..... 41

Drop Kits..... 30

Drop Shackles..... 36

Engine Conversion Kit for Straight Axle.. 47

Engine Mounts & Pads..... 47

Flip Kit with C-Notch..... 36

Frame Stiffeners..... 46

Front End Kits, Complete..... 35

Front End Kits..... 35

Front Shock Mounts..... 37

Front Spring Pin & Shackle Kits..... 41

Grand Slam Kits

Original Offset SOS™..... 28

Drop Kits..... 29

Hotchkis Sport Anti-Squat Bracket System 33

Idler Arms..... 38

IFS Systems..... 20



Page 35

King Pin Set..... 41

Leaf Springs

Conversion Kit..... 45

Rear Kits..... 44

Lowering & Handling Performance Kit... 32

Multi Leaf Springs..... 44

Mustang II

Performance Brake Package..... 20

Open Spider 5 Lug Axle Conversion..... 46

Pitman Arms..... 38

Pro-Touring Kits..... 31

Rear 4-Link Suspension Kits..... 42

Rear Axle Conversion Kit..... 46

Rear Axle Flip Kit..... 45

Rear Ends, Currie Crate..... 46

Rear End Conversion Kit..... 44

Rear Lowering Block Kits & U-bolts..... 37

Rear Pinion Angle Shims..... 46

Rear Shock Crossmember..... 43

Rear Suspension Kit..... 43

Rear Trailing Arms..... 43

Rear Trailing Arms Bushing Kits..... 45

Rear Trailing Arm Reinforcement Kit..... 46

Roller Bearing Hub Upgrade Kit..... 41

Shackle Kits, Rear..... 45

Shocks

CPP Nitrogen Gas Shocks..... 36

RCD Classics Bilstein Shock Absorbers... 36

Ridetech Q Series Shocks..... 36

Drop Shackles..... 36

Front Shock Mounts..... 37

Front & Rear Shock Support Bracket..... 37

Rear Shock Relocator Brackets..... 37

Rear Hangers..... 36

Slip Shaft Driveline..... 46

Sport Anti-Squat Bracket System..... 33

Steering Linkage Kit, Complete..... 39

Suspension Rebuild Kit, Front..... 35

Sway Bars..... 40

Third Members..... 46

Tie Rod Sleeves..... 39

Tie Plates..... 41

Tie Rod Ends..... 39

Trac Bars..... 44

Trac Bar Mount..... 45

Trailing Arm Reinforcement Kit..... 46

Transmission Mounts..... 47

U-bolt Kits

O.E. Square Top..... 37

Block Kits, Rear Lowering..... 37

Weld-On Rear Axle Seats..... 45

STEERING

Alternator Brackets..... 49

Column Floor Mount, Deluxe..... 48

Column Shift Indicator Kits..... 48

Floor Mount Plate..... 48

Intermediate Steering Shaft..... 49

Power Assist Steering Kit..... 50

Power Steering Pump & Brackets, OE-Style Big Block..... 50

Power Steering Pump & Reservoir Kits... 50

Steering Boxes..... 50

Tilt Steering Columns

CPP Classic Fit™..... 48

IDIDIT Steel..... 48

Wire Harness for Steering Column..... 48



Page 50

ACCESSORIES

Bumpers, Chrome..... 56

Gas Tanks

Carberated..... 51

Fuel Injection..... 52

Aluminum..... 51

Stainless Steel..... 53

Steel Zinc Painted..... 54

OEM-Style..... 54

Gas Tank Accessories

Gas Cap..... 55

Filler Neck Grommet..... 55

Fillers..... 55

Floor Seal..... 55

Fuel Line Kit..... 53

Sending Units..... 53

Sender Float, Stock..... 55

Fuel Pump Kits for OE Fuel Injected... 53

Engine Install Kits (LS1, 2, 3 & 6)..... 56

Grilles..... 56

Headers..... 56

Hidden Tow Hitch..... 57

Hood Hinges..... 57

Roll Pans..... 56

Radio Dash Repair Panel..... 56



Page 52

Stealth Tailgate Latches..... 57

Wheel Tubs, Fiberglass..... 55

Wiring Kit, American Autowire Classic... 57

MODULAR™

*Powdercoated calipers upgrade shown.



COMPLETE FRONT/REAR BIG BRAKE KITS

CPP's 13" Big Brake front system uses a 13" cross-drilled, gas slotted and zinc washed rotor, mounted to a 2024 T6 billet aluminum CNC machined anodized hub and a PBR C15 caliper that attaches to the CPP modular drop spindle with CPP custom caliper mounting brackets. PBR C15 calipers have twin 52mm pistons and a larger brake pad surface area that offers about 60% more stopping power in the caliper than the popular C5 caliper at half the cost. Big Brake kits requires a 17" diameter disc brake type wheels (easy-to-use wheel template available). Our Big Brake rear kit utilizes a 12" rotor and Lincoln (e-brake style) caliper. Kits are complete and include front and rear rotors, front and rear loaded calipers, hoses, front bearings and seals, front and rear mounting brackets, forged aluminum hubs, rear hard lines, rear e-brake cables (or adaptors), all necessary hardware and include a 4-wheel disc master cylinder and proportioning valve kit. *Note: Kits are all original drop offset.*

QUICK FACTS...

STOCK/DROP	drop
ROTOR	13" / 12"
CALIPER	(2)52mm/45mm
OFFSET	0
MIN. WHEEL SIZE	17"
BACKSPACING	factory

6366FRBK5-BB	1963-66, 5x5 kit, plain calipers	\$1,798.00
6366FRBK6-BB	1963-66, 6x5.5 kit, plain calipers	\$1,798.00
6770FRBK5-BB	1967-70, 5x5 kit, plain calipers	\$1,798.00
6770FRBK6-BB	1967-70, 6x5.5 kit, plain calipers	\$1,798.00
7172FRBK5-BB	1971-72, 5x5 kit, plain calipers	\$1,798.00
7387FRBK5-BB	1973-87, 5x5 kit, plain calipers	\$1,798.00



BIG BRAKE WHEEL KITS

Lowered truck owners with big wheels, this is the spindle and brake kit you have been waiting for! Our exclusive design gives you 1-1/8" more clearance at the fender and helps solves tire to fender interference commonly found with lowered trucks. For HIGH Performance, this kit combines the modular drop spindle with the CPP 13" rotor twin 52mm piston brake kit. ****Upgrade kits include ball joints and tie rod ends.** *Note: These kits require 17" or larger wheels. Kit is also available with 5x4.75 bolt pattern.*

MODULAR™

QUICK FACTS...

STOCK/DROP	drop
ROTOR	13"
CALIPER	(2) 52mm
OFFSET	0
MIN. WHEEL SIZE	17"
BACKSPACING	factory

REAR BIG BRAKE KIT

Our rear system uses a 12" cross-drilled, gas slotted and zinc washed rotor that mounts to the factory axle with longer studs supplied, and mates up to a Lincoln Continental emergency brake style caliper mounted to the rear axle housing with a CPP custom caliper mounting bracket. Most kits also include hard lines and e-brake cables. This kit requires larger diameter disc brake type 16" wheels. (easy-to-use wheel template available online). These kits work with original rear ends. *Note: Kits also available for Ford 9", please inquire. Also, kits fit original 12 bolt rear ends only.*

QUICK FACTS...

STOCK/DROP	stock
ROTOR	12"
CALIPER	45mm
OFFSET	0
MIN. WHEEL SIZE	16"
BACKSPACING	factory

6062SWBK-55213	1960-62, (5x5), 5 lug, kit	\$1,099.00
6062SWBK-65213	1960-62, (6x5.5), 6 lug, kit	\$1,099.00
6370SWBK-55213	1963-70, (5x5), 5 lug, kit	\$1,099.00
6370SWBK-65213	1963-70, (6x5.5), 6 lug, kit	\$1,099.00
7172SWBK-55213	1971-72, (5x5), 5 lug, kit	\$1,099.00
7172SWBK-65213	1971-72, (6x5.5), 6 lug, kit	\$1,099.00
7387SWBK-55213	1973-87, (5x5), 5 lug, kit	\$1,099.00
7387SWBK-65213	1973-87, (6x5.5), 6 lug, kit	\$1,099.00
6387SWBK-55213**	1963-87, 13", (5x5), 5 lug, kit	\$1,199.00
6387SWBK-65213**	1963-87, 13", (6x5.5), 6 lug, kit	\$1,199.00

6366RWBK-5-P12	1963-66 C-10, 5 lug	\$699.00
6366RWBK-6-P12	1963-66 C-10, 6 lug	\$699.00
6772RWBK-5-P12	1967-72 C-10, 5 lug	\$699.00
6770RWBK-6-P12	1967-70 C-10, 6 lug	\$699.00
7187RWBK-5-P12	1973-87 C-10, 5 lug (no e-brake cables included) <i>*also fits 1963-72 rear leaf spring trucks</i>	\$699.00

CALIPER COLOR UPGRADES:

POWDERCOATED SHOW CALIPERS

(-B) black, (-BLU) blue, (-R) red, or (-S) silver

4 Wheel.....\$200 Front or Rear only..... \$100

PRODUCTION FINISH CALIPERS

(-B) black or (-R) red Front or Rear..... \$55



NOTE: CPP FRONT BIG BRAKE KITS USE D785 BRAKE PADS AND REAR KITS USE D347.

CHEVROLET TRUCK

*Shown with optional upgraded rotors.

#6770FRBK-6



DUST SHIELDS INCLUDED

COMPLETE FRONT & REAR DISC BRAKE KITS

Complete kit for the serious builder looking for the best performance possible. This kit has it all! We have put this kit together to make it easy to buy, with one part number getting you everything you need for the most in front and rear disc brake performance. Upgrades available upon request! *Specify stock or drop spindle. Works with factory ball joints.*

Part Number	Description	Price	Price
6366FRBK-5	1963-66, (5x5), 5-lug, kit	\$1,445.00	
6366FRBK-6	1963-66, (6x5.5), 6-lug, kit	\$1,545.00	
6770FRBK-5	1967-70, (5x5), 5-lug, kit	\$1,445.00	
6770FRBK-6	1967-70, (6x5.5), 6-lug, kit	\$1,545.00	
7172FRBK-5	1971-72, (5x5), 5-lug, kit	\$1,445.00	
7172FRBK-6	1971-72, (6x5.5), 6-lug, kit	\$1,545.00	
	slotted cross drilled rotors upgrade (all 4)		\$150.00

QUICK FACTS...	
STOCK/DROP	both
ROTOR	12", 12"
CALIPER	2.938", 2.125"
OFFSET	0, +.125"
MIN. WHEEL SIZE	15"
BACKSPACING	factory

CHEVROLET TRUCK



*Shown with optional upgraded rotors.



*Shown with optional upgraded rotors.

MODULAR™ DROP SPINDLE COMPLETE FRONT BRAKE KIT

Our exclusive new design gives you 1-1/8" more clearance at the fender and helps solve tire to fender interference commonly found with lowered trucks. Our Modular™ spindle offers many benefits available for the first time, installs easy without modifications, works with factory ball joints and tie rod ends and lowers your truck a full 2-1/2". This kit comes complete with spindles, rotors, loaded calipers, caliper mounting brackets, bearings, seals, hoses, spindle nut kit, mounting hardware, brake booster and brackets, master cylinder and proportioning valve kit. *Note: Booster will fit 1967-70 applications when not wanting the "factory" style booster. Works with factory ball joints.*

MODULAR™

QUICK FACTS...	
STOCK/DROP	drop
ROTOR	12"
CALIPER	2.938"
OFFSET	-.250"
MIN. WHEEL SIZE	15"
BACKSPACING	factory



Included with #6062CBK-5 and #6366CBK-5



Included with #6770CBK-5

6370CBK-5MOD	1963-66, 12", (5x5), 5-lug, kit	\$1,098.00
6370CBK-6MOD	1963-66, 12", (6x5.5), 5-lug, kit	\$1,098.00
	*slotted cross drilled rotors upgrade	\$75.00

5X4.75 COMPLETE FRONT BRAKE KIT

This kit allows you to change your 6-lug drum brakes to the 5-lug on 4-3/4" GM passenger car bolt circle disc brakes. A wheel change is required. Your stock spindle is retained and you get the increased performance of disc brakes. Kit includes rotors, caliper brackets, bearings, seals, spindle nuts, dust caps, banjo bolts, brake hoses, brake booster, master cylinder, proportioning valve and mounting hardware. *Specify type of rear brakes when ordering. Note: Drum brake spindles required, will not work with drop spindles. Pushes wheel out 1.25"*

6062CBK-5	1960-62 (with automatic transmission), kit	\$599.00
6366CBK-5	1963-66, kit	\$599.00
6770CBK-5	1967-70, kit	\$599.00
	*slotted cross drilled rotors upgrade	\$75.00

**MODULAR™
DROP SPINDLE WHEEL
BRAKE KITS**

Our exclusive new design gives you 1-1/8" more clearance at the fender and helps solves tire to fender interference commonly found with lowered trucks. Spindle and brackets works with factory 1971-87 C10 brake components. The ALL NEW CPP Modular Spindle offers many benefits available for the first time, installs easy without modifications, works with factory ball joints and tie rod ends, lowers your truck a full 2-1/2".

QUICK FACTS...	
STOCK/DROP	drop
ROTOR	12"
CALIPER	2.938
OFFSET	-250
MIN. WHEEL SIZE	15
BACKSPACING	factory



MODULAR™



*Custom lug patterns available, please inquire.

*Shown with optional upgraded rotors and hoses.

12" Rotors

6062SWBK-5	1960-62, (5x5), 5 lug, 2 1/2" drop, kit	\$799.00
6062SWBK-6	1960-62, (6x5.5), 6 lug, 2 1/2" drop, kit	\$799.00
6370SWBK-5	1963-70, (5x5), 5 lug, 2 1/2" drop, kit	\$799.00
6370SWBK-6	1963-70, (6x5.5), 6 lug, 2 1/2" drop, kit	\$799.00
7172SWBK-5	1971-72, (5x5), 5 lug, 2 1/2" drop, kit	\$799.00
7172SWBK-6	1971-72, (6x5.5), 6 lug, 2 1/2" drop, kit	\$799.00
7387SWBK-5	1973-87, (5x5), 5 lug, 2 1/2" drop, kit	\$799.00
7387SWBK-6	1973-87, (6x5.5), 6 lug, 2 1/2" drop, kit	\$799.00
	*slotted cross drilled rotors upgrade	\$75.00

*Shown with optional upgraded rotors.



NEW SPINDLE DESIGN

DUST SHIELDS INCLUDED

*Shown with optional upgraded rotors.



**OE DROP SPINDLE
WHEEL BRAKE KITS**

We offer drop or stock spindle disc brake kits that bolt in place using stock suspension components. Each spindle has been designed to accept stock ball joints and tie rod ends, making the switch to disc brakes painless and easy. Kits include 2-1/2" drop spindles, rotors, calipers, bearings, seals, spindle nuts, dust caps, banjo bolts and brake hoses. Wheel kits are available in 5-lug and 6-lug applications. May not work with factory drum brake wheels. *Note: Factory 6-lug applications had 7/16" dia. studs and 5 on 5-lug kits have 1/2" dia. studs. 8-lug kits have a 9/16" dia. studs. Please specify brake line size.*

QUICK FACTS...	
STOCK/DROP	drop
ROTOR	12"
CALIPER	2.938"
OFFSET	0
MIN. WHEEL SIZE	15"
BACKSPACING	factory

6062SWBK-5OE	1960-62, (5x5), 5-lug, drop, kit	\$599.00
6062SWBK-6OE	1960-62, (6x5.5), 6-lug, drop, kit	\$599.00
6370SWBK-5OE	1963-70, (5x5), 5-lug, drop, kit	\$599.00
6370SWBK-6OE	1963-70, (6x5.5), 6-lug, drop, kit	\$599.00
7172SWBK-5OE	1971-62, (5x5), kit	\$599.00
7387SWBK-5OE	1973-87, (5x5), kit	\$599.00
	*slotted cross drilled rotors upgrade	\$75.00

**UPGRADE DROP SPINDLE
WHEEL BRAKE KIT**

Add disc brakes to your truck and upgrade your stock suspension with one of our disc brake upgrade wheel kits. Our upgrade kits use the more readily available, better designed 1973-87 ball joints and tie rod ends. Kits include 2-1/2" drop spindles, rotors, loaded calipers, bearings, seals, dust caps, spindle nuts, banjo bolts, upper and lower ball joints, inner and outer tie rod ends and tie rod adjustment sleeves. Kits are available in 5-lug (5 on 5) and 6-lug applications. May not work with factory drum brake wheels. *Note: Specify hose size.*

QUICK FACTS...	
STOCK/DROP	drop
ROTOR	12"
CALIPER	2.938"
OFFSET	0
MIN. WHEEL SIZE	15"
BACKSPACING	factory

6370SWBK-5D	1963-70 (5x5), 5-lug drop, kit	\$699.00
6370SWBK-6D	1963-70 (6x5.5), 6-lug drop, kit	\$699.00
	*slotted cross drilled rotors upgrade	\$75.00

**Add "-UG" to any kit
for drilled/slotted rotors
and stainless hoses:
+ \$200 for 4 Wheel
+ \$100 for Front or Rear only**



Add -WWB (black) or -WWR (red) to any front kit

Not available for Big Brake Kit

Includes: Upgrade to Wilwood D52 red or black calipers, cross drilled & gas slotted rotors, and stainless hoses.

\$199.00

Note: Purchase of brake kit required.



POWDERCOATED SHOW CALIPER UPGRADES:

(-B) black, (-BLU) blue, (-R) red, or (-S) silver
4 Wheel.....\$200 Front or Rear only..... \$100

PRODUCTION FINISH CALIPER UPGRADES:

(-B) black or (-R) red Front or Rear..... \$55



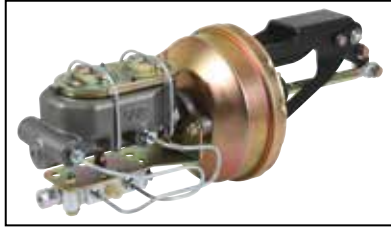

QUICK FACTS...

STOCK/DROP	stock
ROTOR	12"
CALIPER	2.938"
OFFSET	+0.0625"
MIN. WHEEL SIZE	15"
BACKSPACING	factory



*Shown with optional upgraded rotors and hoses.

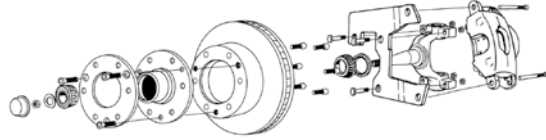

6-LUG COMPLETE FRONT BRAKE KIT

Our 6-lug disc brake kit contains all you'll need to put modern discs on your stock 1/2 ton spindles, and keep your original pattern. The 1-1/4" thick, 12" rotor uses a GM full-floating caliper. The 8" single diaphragm booster master cylinder and proportioning valve mounts in the stock location. The kit uses tapered roller bearings and new forged hub with the hub upgrade kit. Standard kit uses original hubs. May not work with some stock wheels. Also, 1947-50 trucks may need to drill out lower spindle hole from 7/16" to 1/2". 1955-59 models can upgrade to firewall booster at no charge. *Note: Frame mount brake boosters may require #CP9424 transmission mount. May not work with manual transmission or stock wheels, please inquire. Kit uses 7/16 wheel studs. Booster will not clear stock clutch linkage.*

The 8" single diaphragm booster master cylinder and proportioning valve mounts in the stock location. The kit uses tapered roller bearings and new forged hub with the hub upgrade kit. Standard kit uses original hubs. May not work with some stock wheels. Also, 1947-50 trucks may need to drill out lower spindle hole from 7/16" to 1/2". 1955-59 models can upgrade to firewall booster at no charge. *Note: Frame mount brake boosters may require #CP9424 transmission mount. May not work with manual transmission or stock wheels, please inquire. Kit uses 7/16 wheel studs. Booster will not clear stock clutch linkage.*

4954CBK-6HK	1947-54 with hub upgrade, kit	\$749.00
4954CBK-6	1947-54 6-Lug Complete Brake, kit	\$649.00
5559CBK-6HK	1955-59 with hub upgrade, kit (shown)	\$749.00
5559CBK-6	1955-59 6-Lug Complete Brake, kit	\$649.00
	*slotted cross drilled rotors upgrade	\$75.00



*Shown with optional upgraded rotors.

QUICK FACTS...

STOCK/DROP	stock
ROTOR	11"
CALIPER	2.938"
OFFSET	+4.375"
MIN. WHEEL SIZE	15"
BACKSPACING	factory

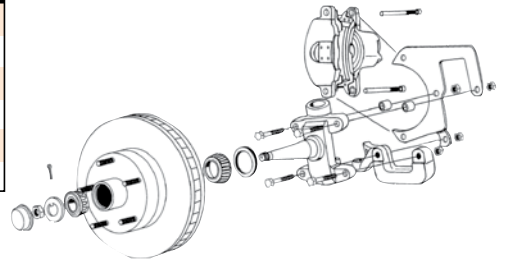

5-LUG COMPLETE FRONT BRAKE KIT

Our 5-lug disc brake kit not only upgrades your brakes, but swaps the factory 6-lug pattern to the common GM 5 on 4-3/4" bolt pattern. The kit is complete, bolts onto the stock spindle, and does not use stock hubs. Includes 1" thick 11" diameter rotors, tapered roller bearings, hoses, master cylinder, booster, and proportioning valve. 1947-50 trucks may need to drill out lower spindle hole from 7/16" to 1/2". 1954-59 models can upgrade to firewall booster at no charge. *Note: Both factory 6-lug and our 5-lug kit have 7/16" dia studs. Frame mount brake boosters may require #CP9424 transmission mount. May not work with manual transmission. Booster will not clear stock clutch linkage.*

4754CBK-5	1947-54 5-Lug Complete Brake, kit	\$649.00
5559CBK-5	1955-59 5-Lug Complete Brake, kit	\$649.00
	*slotted cross drilled rotors upgrade	\$75.00

Add "-UG" to any kit for drilled/slotted rotors and stainless hoses:

+ \$200 for 4 Wheel
+ \$100 for Front or Rear only



Add -WWB (black) or -WWR (red) to any front kit

Not available for Big Brake Kit

Includes: Upgrade to Wilwood D52 red or black calipers, cross drilled & gas slotted rotors, and stainless hoses.

\$199.00

Note: Purchase of brake kit required.



POWDERCOATED SHOW CALIPER UPGRADES:

(-B) black, (-BLU) blue, (-R) red, or (-S) silver
4 Wheel.....\$200 Front or Rear only..... \$100

PRODUCTION FINISH CALIPER UPGRADES:

(-B) black or (-R) red Front or Rear..... \$55



*Shown with optional upgraded rotors.



STOCK HEIGHT 6-LUG WHEEL BRAKE KIT

Our 6-lug disc brake kit contains all you'll need to put modern discs on your stock 1/2 ton spindles, and uses your stock hub. The 1-1/4" thick, 12" rotor uses a GM full-floating caliper. We recommend that you upgrade the stock ball bearings to tapered roller bearings (#4759RBK-U) when using this kit. Some stock wheels may rub the caliper, it may be necessary to use a spacer. May not work with some stock wheels. Also, 1947-50 trucks may need to drill out lower spindle hole from 7/16" to 1/2". *Note: See info on hub kit on page 15.*



4959WBK-6	1947-59, 6 on 5-1/2", kit	\$375.00
4959WBK-6HK	1947-59, 6 on 5-1/2", with hub kit	\$475.00
4759RBK	Roller Bearing Upgrade (for #4959WBK-6), kit	\$95.00
	*slotted cross drilled rotors upgrade	\$75.00

*Shown with optional upgraded rotors and hoses.



OE STOCK SPINDLE WHEEL BRAKE KIT

We offer drop or stock spindle disc brake kits that bolt in place using stock suspension components. Each spindle has been designed to accept stock ball joints and tie rod ends, making the switch to disc brakes painless and easy. Kits include stock spindles, rotors, calipers, bearings, seals, spindle nuts, dust caps, banjo bolts and brake hoses. Wheel kits are available in 5-lug and 6-lug applications. May not work with factory drum brake wheels. *Note: Factory 6-lug applications had 7/16" dia. studs and 5 on 5-lug kits have 1/2" dia. studs. 8-lug kits have a 9/16 dia. studs. Please specify brake line size.*

QUICK FACTS...	
STOCK/DROP	stock
ROTOR	12"
CALIPER	2.938"
OFFSET	0
MIN. WHEEL SIZE	15"
BACKSPACING	factory

6062SWBK-50E-S	1960-62, (5x5), 5-lug, stock, kit	\$599.00
6062SWBK-60E-S	1960-62, (6x5.5), 6-lug, stock, kit	\$599.00
6370SWBK-50E-S	1963-70, (5x5), 5-lug, stock, kit	\$599.00
6370SWBK-60E-S	1963-70, (6x5.5), 6-lug, stock, kit	\$599.00
	*slotted cross drilled rotors upgrade	\$75.00

*Shown with optional upgraded rotors.



#6370WBK-5

STOCK HEIGHT 5-LUG WHEEL BRAKE KIT

This kit contains everything at the spindle needed to change your 6-lug drum brakes to 5-lug on 4-3/4" GM passenger car bolt circle disc brakes while retaining the stock spindles. Kit includes 1969-74 Chevelle rotors, 1969-72 Camaro calipers, caliper brackets, bearings, seals, spindle nuts, dust caps, brake hoses and banjo bolts. Caliper bracket kit also available separately. *Note: Factory 6-lug applications and 5-lug on 4-3/4" kits have 7/16" diameter studs.*

QUICK FACTS...	
STOCK/DROP	stock
ROTOR	11"
CALIPER	2.938"
OFFSET	+1.25"
MIN. WHEEL SIZE	15"
BACKSPACING	factory

4759WBK-5	1947-59, 5 on 4-3/4", kit	\$375.00
6062WBK-5	1960-62, 5 on 4-3/4", kit	\$375.00
6370WBK-5	1963-70, 5 on 4-3/4", kit	\$375.00
	*slotted cross drilled rotors upgrade	\$75.00

*Shown with optional upgraded rotors and hoses.



UPGRADE STOCK SPINDLE WHEEL BRAKE KIT

BACKING PLATES INCLUDED

Add disc brakes to your truck and upgrade your stock suspension with one of our disc brake upgrade wheel kits. Our upgrade kits use the more readily available, better designed 1973-87 ball joints and tie rod ends. Kits include stock height spindles, rotors, loaded calipers, bearings, seals, dust caps, spindle nuts, banjo bolts, upper and lower ball joints, inner and outer tie rod ends and tie rod adjustment sleeves. Kits are available in 5-lug (5 on 5), 6-lug and 8-lug applications. May not work with factory drum brake wheels. *Note: Specify hose size.*

QUICK FACTS...	
STOCK/DROP	stock
ROTOR	12"
CALIPER	2.938"
OFFSET	0
MIN. WHEEL SIZE	15"
BACKSPACING	factory

6370SWBK-5S	1963-70 (5x5), 5-lug stock, kit	\$699.00
6370SWBK-6S	1963-70 (6x5.5), 6-lug stock, kit	\$699.00
6370SWBK-8S	1963-70 (8 lug), 8-lug stock, (does not include dust shields), kit	\$899.00
	*slotted cross drilled rotors upgrade	\$75.00



BAER PRO+ FRONT BRAKE SYSTEM

The Pro+ will allow you to upgrade to a two piece rotor (a popular upgrade due to cosmetics and weight savings). This is the first system they offer that will allow you to have

the exact same looking brake front and rear! This kit is a 14" two piece rotor and utilizes brake pads from the 1997-2012 C5 & C6 Corvette. Calipers available in black (B), red (R), or silver (S). *Note: Must use CPP Modular™ spindles.*



CALIPERS AVAILABLE IN:
BLACK (-B), RED (-R),
or SILVER (-S)



BAER EXTREME+ FRONT BRAKE SYSTEM

The Extreme+ is Baer's flagship offering, featuring a forged monoblock caliper that is mounted to a 14" two-piece rotor.

The Extreme+ employs current state-of-the-art race technology usually only found in very expensive race calipers, that Baer now brings to the road going/street market. The 6S line represents Baer's most aggressive road offering and is suitable for virtually any level of track use. If you are looking for the best of the best, this is it. *Note: Must use CPP Modular™ spindles.*



CALIPERS AVAILABLE IN:
BLACK (-B), RED (-R),
or SILVER (-S)



4301388	1960-87, 5-lug	\$2,295.00
4301389	1960-70, 6-lug	\$2,295.00

4301390	1960-87, 5-lug	\$3,595.00
4301391	1960-70, 6-lug	\$3,595.00



WILWOOD WHEEL BRAKE KIT

Superlite 6 Big Brake Front Hub kits are engineered as complete assemblies for conventional front spindle applications. Billet Superlite 6 piston calipers, PolyMatrix brake pads, forged aluminum hubs, machined aluminum hats, and 13" or 14" SRP or GT directional vane rotors exemplify award-winning style and provide the ultimate in Big Brake stopping power. Born from Wilwood's 25 year tradition of building championship brake systems, SL6 Big Brake kits are the perfect compliment to wheel, tire, and suspension equipment upgrades. *Note: Only works with CPP 2-1/2" Modular spindle included in kit. Specify black or red calipers. Also, kits are 5x5 and 5x4.75 dual lug pattern. Not available in 6-lug.*

6062SWBK-WW13	1960-62, 13" kit	\$1,989.00
6062SWBK-WW14	1960-62, 14" kit	\$2,339.00
6370SWBK-WW13	1963-70, 13" kit	\$1,989.00
6370SWBK-WW14	1963-70, 14" kit	\$2,339.00
7172SWBK-WW13	1971-72, 13" kit	\$1,989.00
7172SWBK-WW14	1971-72, 14" kit	\$2,339.00
7387SWBK-WW13	1973-87, 13" kit	\$1,989.00
7387SWBK-WW14	1973-87, 14" kit	\$2,339.00

Are you stuck?

Grab our Brake & Power Steering Installation Guide...

Call for a copy today or access it on our website 24 hours a day

@ www.ClassicPerform.com

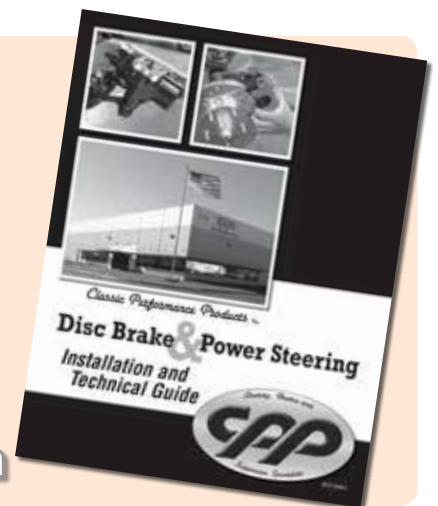

QUICK FACTS...	
STOCK/DROP	n/a
ROTOR	11"
CALIPER	2.5"
OFFSET	+ .125"
MIN. WHEEL SIZE	15"
BACKSPACING	n/a



*Shown with optional upgraded rotors.

Complete Kit with Hard Lines & Cables



Upgrade starting at \$199/kit

WILWOOD BRACKET KIT UPGRADE

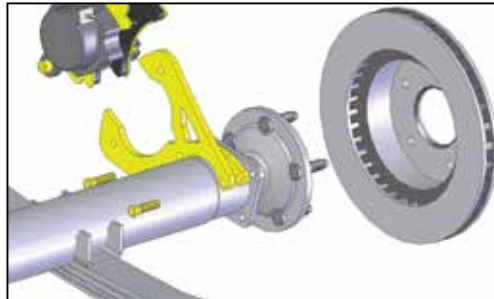

CPP LARGE GM FLANGE REAR BRAKE KIT

All kits work with a stock rear-end. All are easy bolt-on installations. Kits include: rotors, loaded calipers with built-in E-brake, rubber hose kit, E-brake cable, and all mounting hardware. Will work with C-clip eliminators. Some modifications may be necessary. Note: Kits will not fit early 1963 with pressed-on backing plates. #636EBC does not fit long beds, custom line cable required. Also, kits fit original 12 bolt rear end only. These kits will NOT fit Dana rear ends.

5559RWBK-6E	1955-59 6-lug w/ E-brake, kit (does not include cables or hard lines)	NEW!	\$599.00
5559RWBK-6S	1955-59 6-lug w/o E-brake, kit (does not include cables or hard lines)	NEW!	\$549.00
6366RWBK-5E	1963-66 5-lug w/ E-brake, kit		\$599.00
6366RWBK-6E	1963-66 6-lug w/ E-brake, kit		\$599.00
6366RWBK-6S	1963-66 6-lug w/o E-brake, kit		\$499.00
6772RWBK-5E	1967-72 5-lug w/ E-brake, kit (shown)		\$599.00
6772RWBK-5S	1967-72 5-lug w/o E-brake, kit		\$499.00
6772RWBK-6E	1967-72 6-lug w/ E-brake, kit		\$599.00
6772RWBK-6S	1967-72 6-lug w/o E-brake, kit		\$499.00
7187RWBK-5E	1973-87 5-lug w/ E-brake, kit (does not include cables or hard lines)		\$599.00
7187RWBK-5S	1971-87 5-lug w/o E-brake, kit (does not include hard lines)		\$499.00

5-Lug Axle Conversions Available!

See page 46 in the Chevy Truck suspension section



CALIPER COLOR UPGRADES:

POWDERCOATED SHOW CALIPERS

(-B) black, (-BLU) blue, (-R) red, or (-S) silver

4 Wheel.....\$200 Front or Rear only..... \$100

PRODUCTION FINISH CALIPERS

(-B) black or (-R) red Front or Rear..... \$55



Add "-UG" to any kit

for drilled/slotted rotors and stainless hoses:

+ \$200 for 4 Wheel

+ \$100 for Front or Rear only

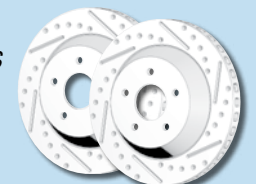

Remember when upgrading to disc brakes you must upgrade to a disc brake master cylinder and proportioning valve.

Shown with upgraded rotors, calipers and hoses



QUICK FACTS...

STOCK/DROP	n/a
ROTOR	11"
CALIPER	2.125"
OFFSET	+ .125"
MIN. WHEEL SIZE	15"
BACKSPACING	n/a

NEW CALIPERS!

CPP 9" FORD FLANGE REAR BRAKE KITS

We now offer bolt-on rear disc brake kits for cars and trucks using the always popular Ford 9" rear end. Perfect for the enthusiast that has upgraded his rear end and now wants the ultimate in braking. Kits include rotors, calipers, caliper mounting brackets, rubber hose kit, and mounting hardware. *Note: All kits work with small or large bearings. Caliper brackets work with both 2.37" and 2.50" for 9" flange. 3/8 flange bolt kits will also fit 8" Ford rear end.*

CP2505-38-5500	Ford truck 9" w/ 3/8" flange bolts (5x5 bolt pattern), kit	\$599.00
CP2505-38-6512	Ford truck 9" w/ 3/8" flange bolts (6 lug bolt pattern), kit	\$599.00
CP2505-50-5500	Ford truck 9" w/ 1/2" flange bolts (5x5 bolt pattern), kit	\$599.00
CP2505-50-6512	Ford truck 9" w/ 1/2" flange bolts (6 lug bolt pattern), kit	\$599.00
	*slotted cross drilled rotors upgrade	\$75.00



REAR AXLE FLEX HOSE

These replacement hoses mount on the axle and connects the hardlines to the wheels. For original rear end only.

RFH117	1938-56, 3100	\$14.00
RFH39	1957-59, 3100	\$10.00
RFH128	1960, C10 Long Bed	\$14.00
RFH129	1961-62, C10 Short Bed	\$14.00
RFH126	1963-66, C10 Short Bed	\$16.00
RFH130	1963-66, C10 Long Bed	\$16.00
RFH103	1967-70, C10 with coil springs	\$16.00
RFH131	1968-70, C10 BB leaf	\$16.00
RFH112	1969-70, C10 SB leaf	\$16.00
RFH132	1971-72, C10 with coil springs	\$16.00
RFH104	1971-72, C10 leaf	\$16.00
RFH108	1974-86, C10	\$15.00



BAER SS4+ REAR BRAKE SYSTEM

This kit features a 13" two-piece rotor with drum in hat park brake. The billet backing plate supplied with the SS4 is rear specific and is available in a number of varieties. The SS4 for c-clip rears feature their unique VeriSlide mounting technology that allows a fix mounted caliper (4 piston) to properly work on a floating (c-clip) axle.

CALIPERS AVAILABLE IN: BLACK (-B), RED (-R), or SILVER (-S)



4302339	1963-87, 5 lug, kit	\$1,445.00
4302340	1963-87, 6 lug, kit	\$1,445.00



WILWOOD REAR WHEEL BRAKE KITS

Wilwood brake kits are loaded with cutting edge disc brake technology and backed by Wilwood's 25 year tradition of building championship brake systems. These kits provide Big Brake stopping power and are the perfect compliment to wheel, tire, and suspension system upgrades. 13" kits use the Superlite 4R 4 piston caliper and 12" kits use the Dynalyte 4 piston caliper.

Hoses not included, use part #220-7056.
Note: Rotor finish may vary.

140-10093	C-10, Rear End 13" rotor 2.42 offset, kit	\$1,495.00
140-9213-D	Chevy, 12 Bolt, 2.81" offset, 13" rotor, kit	\$1,595.00
140-7141	Chevy, 12 Bolt, 2.81" offset, 12" rotor, kit	\$649.00
140-7149	Chevy, 12 Bolt, 2.75" offset, 12" rotor, kit	\$649.00
220-7056	Stainless steel braided hose kit	\$63.00

WILWOOD D154 REAR BRAKE KIT

Complement that front Wilwood D52 kit with this 12" rear kit that utilizes the new D154 caliper. Rotors are multi pattern and fit 5x4.5, 5x4.75 or 5x5 lug circle. Available with black or red caliper. Kits come standard with drilled one-piece rotors and black calipers. For red caliper, add (R) to end of part number. Inquire for plain rotors and other rear ends. Brake hoses sold separately.



*Add (R) to end of part number for red caliper.



Be sure to order a new E-brake cable:
#330-9371 \$120.00

140-12569-D	C10, Chevy 2.42 offset with 5x5, kit	\$794.00
140-12209-D	Big Ford, new style 2.50 offset, kit	\$769.00
140-12216-D	Big Ford, new style 2.36 offset, kit	\$769.00
BHK-SAN	Stainless steel hose	\$45.00
330-9371	E-brake cable	\$120.00

REAR HOUSING FLANGE CHART AND AXLE FLANGE/OFFSET CROSS SECTION

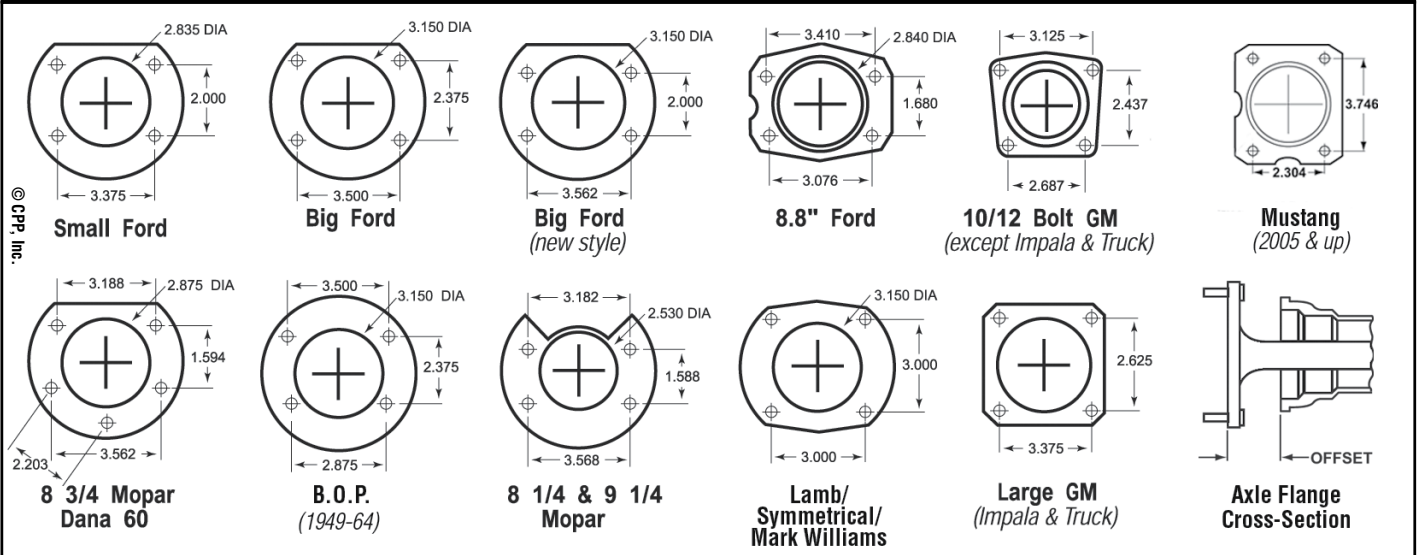

CHEVROLET TRUCK



MINI™ DISC KITS

Kits include the specialty parts you can't buy just anywhere. Save on freight with just the necessities. Kits work with components available at your local auto parts store. Backed by our limited CPP lifetime warranty. Available with stock or 2-1/2" drop spindles. *Note: #7172DSK only includes upper ball joints and outer tie rod ends.*

6370SSK	1963-70 stock, kit	\$339.00
6370SSK-C20	1963-70 C-20 stock, kit	\$619.00
6370DSK	1963-70 drop, kit	\$339.00
7172DSK	1971-72 drop, kit	\$269.00



2-1/2" MODULAR™ DROP SPINDLES

In a continued effort to bring fresh new products to the marketplace, CPP introduces their Modular™ Drop Spindle. One-piece forged nodular iron design with pressed in alloy steel axle pin; installs with no modifications; lowers your vehicle 2-1/2". This is accomplished without moving the wheels out! When using the bracket kits, they work with rotors and calipers that you can purchase at your local parts store. They also work with CPP big brake and many manufacturers brake kits in a host of different brake sizes...ideal for today's larger wheels.

Note: Bracket required when using stock 12" brake components. Puts wheels at stock drum offset.



CP30106-1	1960-62, pair	\$299.00
CP30106-2	1963-70, pair	\$299.00
CP30106-3	1971-72, pair	\$299.00
CP30106-4	1973-87, pair	\$299.00
CP30106-HD2	1963-70, 3/4 ton to 1/2 brakes, pair	\$299.00
CP30106-HD3	1971-87, 3/4 ton to 1/2 brakes, pair	\$299.00
6087DBK	1960-87, brackets, pair	\$75.00



C10 DISC BRAKE SPINDLES

Make your truck disc brake compatible with a set of our disc brake spindles. These are the same spindles sold in our OEM kits and upgrade kits. Cast from the highest quality Ductile Iron with 4140 Chrom-moly CNC machined pins. Accepts factory ball joints and tie rod ends. Designed to use 1971-87 1-1/4" rotors, calipers and bearings.



CP4S1	1960-62, 2-1/2" drop, set	\$239.00
CP4S2	1963-70, 2-1/2" drop, set	\$239.00
CP4S3	1971-72, 2-1/2" drop, set	\$239.00
CP4S4	1973-87, 2-1/2" drop, set	\$239.00
CP4S5	1973-87, stock height, set	\$239.00
CP4S6	1971-87, C-20 stock height, set	\$239.00
CP4S8	1960-62, stock height, set	\$239.00
CP4S9	1963-70, stock height, set	\$239.00
CP4S10	1971-72, stock height, set	\$239.00



2" DROP SPINDLES FOR S-10 TRUCKS

These cast iron spindles allow you to drop your truck 2" and utilize your original rotors and calipers.

DT-100228	1982-03 S-10, 2" drop, pair	\$219.00
------------------	-----------------------------	-----------------



DROP SPINDLES

DT-100699	1999-06 Silverado/Tahoe/Sub/Ava/Esc/Den 2" Drop	\$169.00
DT-101320	2007-08 Silverado/Tahoe/Sub/Ava/Esc/Den 2" Drop	\$199.00
DT-100645	88-91 C1500 Light Duty 2" Drop, 1" rotor, Small spud	\$159.00
DT-100629	88-98 C1500, 95-99 Tahoe, 92-98 Sub 2" Drop, 1.25" rotor, Large spud	\$159.00
DT-100228	82-94 S10 2" drop	\$159.00

See page 340-341 for wheel offset chart



Shown with upgraded components

SPINDLE BRAKE COMPONENTS & KITS

Top quality rotors, calipers, hoses, bearings and seals...all the parts necessary to turn your drop spindles into a complete brake system. Deluxe (UG) kits come with drilled/slotted rotors and stainless steel hoses. Standard kits come with plain rotors and rubber hoses. Kits include rotors, calipers, brake hoses, bearings, seals, banjo bolts and spindle nut kits. Individual components also available.

CP4CK-5	C-10 5x5 Component kit	\$325.00
CP4CK-5WWB	C-10 5x5 Component kit (with black Wilwood D52 calipers)	\$525.00
CP4CK-5WWR	C-10 5x5 Component kit (with red Wilwood D52 calipers)	\$525.00
CP4CK-6	C-10 6-lug Component kit	\$325.00
CP4CK-6WWB	C-10 6-lug Component kit (with black Wilwood D52 calipers)	\$525.00
CP4CK-6WWR	C-10 6-lug Component kit (with red Wilwood D52 calipers)	\$525.00
CP4R-5	C-10 5-lug Disc Brake Rotors, pair	\$99.00
CP4R-6	C-10 6-lug Disc Brake Rotors, pair	\$129.00
ARGX-8600L/R	C-10 5-lug 1963-87 Chevy C-10, drill/slot, pair	\$219.00
ARGX-8600SBL/R	C-10 6-lug 1963-87 Chevy C-10, drill/slot, pair	\$219.00
CP4R-8	C-20 8-lug Disc Brake Rotors, pair	\$149.00
CP4C	C-10 Disc Brake Calipers, pair	\$98.00
CP5C	C-20 Disc Brake Calipers, pair	\$98.00
CP4B	C-10 Wheel Bearing (incl. inner bearings, outer bearings & grease seals), kit	\$29.00
CP5B	C-20 Wheel Bearing (incl. inner bearings, outer bearings & grease seals), kit	\$89.00



5-LUG ON 4-3/4" BOLT PATTERN DISC BRACKET KIT

Convert your drum brake spindle truck to disc brakes with our bracket kit. A true bolt-on kit using the factory holes on the 1/2 ton spindle. Blanchard ground to exact specs. Allows for perfect caliper fit. Includes caliper brackets, bearing adapters and mounting hardware. Uses 1970-77 Camaro rotors and calipers. (Bearing kit #4759BK recommended.)

4759DBK-5	1947-59, kit	\$95.00
6062DBK-5	1960-62, bracket kit	\$119.00
6370DBK-5	1963-70, bracket kit	\$119.00

OEM-STYLE DISC BRAKE DUST SHIELDS

Stock type disc brake dust shields. Works with OE-style disc brakes. Also works with CPP OE-style stock and drop spindles.



CPDS-10	1960-87, 1/2 ton, pair	\$49.00
----------------	------------------------	----------------

PERFORMANCE ROLLER BEARING KIT

Convert your original ball bearings to modern tapered roller bearings. Tapered bearings disperse heat better and can deal with today's grooved roads and modern wheels and tires much better than the original ball type. New and improved seal! Highly recommended for use with the 6-lug disc brake conversion kit.



4759RBK	1947-59 Roller Bearing Kit	\$95.00
6064	Seal only, each	\$9.00

5-LUG BEARING KIT

Kit includes inner and outer bearings and grease seals. A must when converting to 5-lug disc brakes. (Use with #4759DBK)



4759BK	kit	\$30.00
---------------	-----	----------------

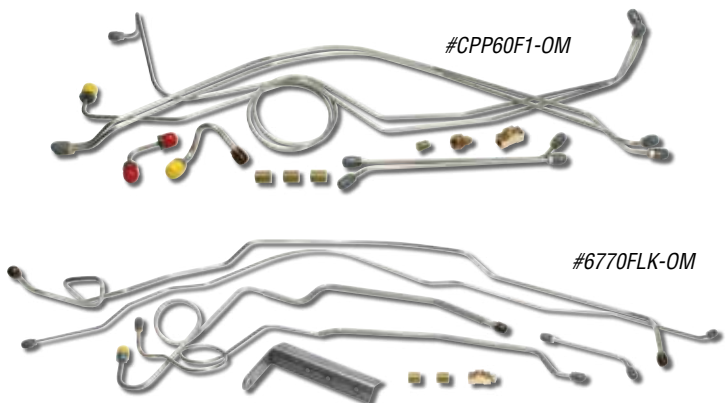

BRAKE LINE KITS

We've got power brake pre-bent lines, rear axle lines for disc applications. Pre-bent line kits require no bending or flaring of lines, just bolt them in. Most line kits are available in original material (OM) or stainless steel (SS). *Note: Some line kits ship O/S; additional freight charges apply. Also, #6770FLK-OM and #6770FLK-SS must use supplied prop valve bracket.*

CPP60F1-OM	1960-66 front, original material, kit	\$95.00
CPP60F1-SS	1960-66 front, stainless steel, kit	\$110.00
6770FLK-OM	1967-70 front, original material, kit	\$115.00
6770FLK-SS	1967-70 front, stainless steel, kit	\$130.00
6772RLK-OM*	1967-72 rear, original material (rear disc brakes), kit	\$35.00
6772RLK-SS*	1967-72 rear, stainless steel (rear disc brakes), kit	\$50.00
6772RLK-CURRIE-OM	1967-72 rear, original material (rear disc brakes), kit	\$40.00
6772RLK-CURRIE-SS	1967-72 rear, stainless steel (rear disc brakes), kit	\$550.00

*Will not work with leaf springs.



REAR DISC EMERGENCY BRAKE CABLES

Rear emergency brake cables are made to connect the original front cables to the new Cadillac Seville rear calipers. Cables are made specifically for each application to ensure an easy installation and fit. *Note: Will not fit drum applications.*

4755EBC	1947-54, pair	\$89.00
5559EBC	1955-59, pair	\$89.00
6366EBC	1963-66, pair (will not fit long bed)	\$89.00
6772EBC	1967-72, pair	\$69.00



#4753FBB2
#5559FBB2

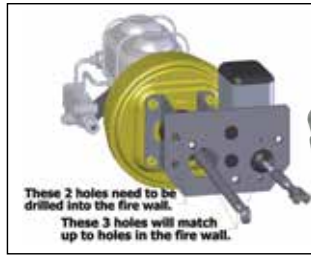

These 2 holes need to be drilled into the fire wall.
These 3 holes will match up to holes in the fire wall.

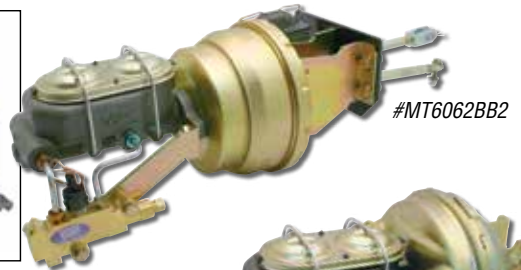

#MT6062BB2

ASK ABOUT CHROME UPGRADES!



#6772BB2

NEW



#7387BB-MC



#6062BB2
#6366BB2

FIREWALL BRAKE BOOSTER KITS

Due to higher line pressures required with disc brakes, it is recommended that a power assist unit be added to the system. These vacuum assist units are the solution! Firewall brake booster units tuck to the firewall and include a firewall seal to prevent fumes from entering the vehicle. Kit includes booster and 3/16" mounting brackets, linkage to connect to the pedal, firewall seal, and master cylinder. Disc/drum and disc/disc kits also include proportioning valve and bracket assembly. #MT6062BB kits also include hydraulic clutch cylinder. Kits available in 7", 8", 9" or 11" and both single and dual diaphragm. If not specified, default booster diameter for your application will be provided. Note: #7387BB-MC and drum/drum kits do not include proportioning valve assembly. Also, 1955-59 will work with factory E-brake handle.

4753FBBBD	1947-53 drum/drum, kit	\$299.00	6062BB2	1960-62 disc/drum, kit	\$299.00
4753FBB2	1947-53 disc/drum, kit	\$299.00	6062BB4	1960-62 disc/disc, kit	\$299.00
4753FBB4	1947-53 disc/disc, kit	\$299.00	6366BBBD	1963-66 drum/drum, kit	\$299.00
5559FBBBD	1955-59 drum/drum, kit	\$299.00	6366BB2	1963-66 disc/drum, kit	\$299.00
5559FBB2	1955-59 disc/drum, kit	\$299.00	6366BB4	1963-66 disc/disc, kit	\$299.00
5559FBB4	1955-59 disc/disc, kit	\$299.00	6772BBBD	1967-72, drum/drum, kit	\$289.00
MT6062BBBD	1960-62 with M/T drum/drum, kit	\$449.00	6772BB2	1967-72, disc/drum, kit	\$299.00
MT6062BB2	1960-62 with M/T disc/drum, kit	\$449.00	6772BB4	1967-72, disc/disc, kit	\$299.00
MT6062BB4	1960-62 with M/T disc/disc, kit	\$449.00	7387BB-MC	1973-87, disc/drum, kit	\$299.00
6062BBBD	1960-62 drum/drum, kit	\$299.00			

CHEVROLET TRUCK

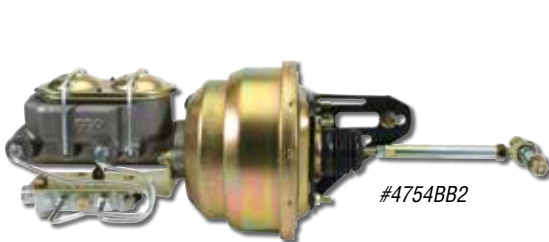

#4754BB2

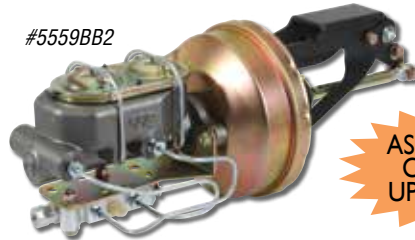

#5559BB2

ASK ABOUT CHROME UPGRADES!



#CP632BB-MC

FRAME MOUNT BRAKE BOOSTER KITS

Due to higher line pressures required with disc brakes, it is recommended that a power assist unit be added to the system. These vacuum assist units are the solution! Frame mount booster kits bolt directly to where the original master cylinder mounted. Some kits include the pedal and others utilize the original pedal. Kits include: booster and frame mount brackets, linkage to connect to the pedal, and master cylinder. Disc/drum and disc/disc kits also include proportioning valve and bracket assembly. Kits available in 7" or 8" and both single and dual diaphragm. If not specified, default booster diameter for your application will be provided. Note: #CP632BB-MC and #CP633BB-MC kits do not include proportioning valve assembly. Also, may require #CP9424 transmission mount. Will not work with factory manual transmission clutch linkage.

CP632BB-MC	1947-54 with pedal, kit	\$229.00
4754BBBD	1947-54 drum/drum, kit	\$299.00
4754BB2	1947-54 disc/drum, kit	\$299.00
4754BB4	1947-54 disc/disc, kit	\$299.00
CP633BB-MC	1955-59 with pedal, each	\$229.00
5559BBBD	1955-59 drum/drum, each	\$299.00
5559BB2	1955-59 disc/drum, each	\$299.00
5559BB4	1955-59 disc/disc, each	\$299.00

Power Disc Booster Install Kit

Save yourself some time and tech phone calls with our install kit. When adding CPP brakes, these helpful tools will make your job much easier. These kits include the vacuum fitting, 25" or 50" vacuum hose, prop valve tool and curved tip syringe bleeder.



#PDBI-K25 (25" hose)	\$27.00
#PDBI-K50 (50" hose)	\$29.00



**HYDRA STOP™
HYDRAULIC ASSIST SYSTEMS**

We now offer a high-quality direct bolt-in hydraulic assist kit designed to upgrade manual or vacuum-assisted brakes with a powerful and compact modern hydraulic assist unit. These systems include everything you need to install into your vehicle. Most installations can be accomplished in an afternoon, using common hand tools, with average mechanical skill levels. These systems consist of a direct fit high performance, hydraulic brake assist unit (with options for steel or billet aluminum firewall mounting bracket); braided stainless or rubber, high pressure line set ; heavy duty power steering return line; pedal rod hardware and mounting hardware. Using all new parts, this unit puts out an amazing 1800psi at the wheels! The "Show Stopper" package includes: Hydraulic Assist unit with billet aluminum firewall mounting bracket, chrome master cylinder with chrome adjustable prop valve and distribution block, chrome accumulator cover, stainless pressure hoses, rubber return hoses and all necessary fittings and hardware for installation. The "Street Beast" package includes: Hydraulic Assist Unit with steel firewall mounting bracket, aluminum Corvette-style master cylinder, side mounted Prop & Stop Block kit, rubber pressure and return hoses and all necessary fittings and hardware for installation. Bare Units are Hydraulic Assist only, master cylinder and hoses are not included. Note: Bare units must be used with 1-1/8" bore master cylinder.

COMPLETE KITS:

6772HBK-SS	1967-72, Show Stopper, kit	\$979.00
6062HBK-SB	1960-62, Street Beast, kit	\$829.00
6366HBK-SB	1963-66, Street Beast, kit	\$829.00
6772HBK-SB	1967-72, Street Beast, kit	\$829.00
7387HBK-SB	1973-87, Street Beast, kit (*use factory prop valve or upgrade)	\$809.00
MT6062HBK-SB	1960-62 Hydraulic Clutch Street Beast	\$829.00
MT6062HBK-SS	1960-62 Show Stopper	\$979.00
6062HBK-SS	1960-62 Show Stopper	\$979.00
6366HBK-SS	1963-66 Show Stopper	\$979.00

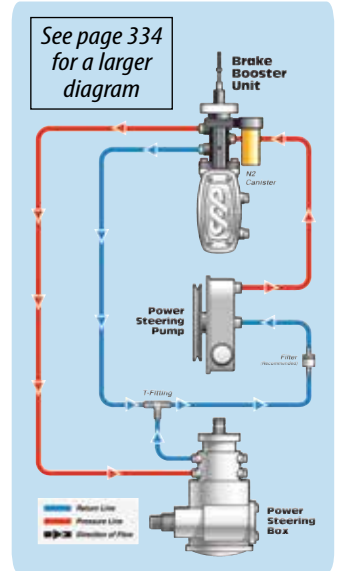

HYDRAULIC BRAKE ASSIST BARE UNITS



6772HBK-BSS	1967-72, billet bracket, each	\$549.00
6062HBK-BSB	1960-62, steel bracket, each	\$469.00
6366HBK-BSB	1966-66, steel bracket, each	\$469.00
6772HBK-BSB	1967-72, steel bracket, each	\$469.00
7387HBK-BSB	1973-87, steel bracket, each	\$469.00
MT6062HBK-BSB	1960-62 Hydraulic Clutch steel bracket	\$469.00



HYDRAULIC BRAKE ASSIST HOSE KITS

HAK-S	Stainless Hose, kit	\$199.00
HAK-R	Rubber Hose, kit	\$115.00

For more Prop Valve options...

See page 270



HYDRAULIC BRAKE ASSIST ACCESSORIES

Our new Install Kit features an in-line filter, fitting kit and brake bleeding syringe. Our in-line filtration extends steering system life and ensures proper performance over the long haul. The fitting kit consists of three brake line adapters with 3/8-24 inverted flare male and three different inverted flare female ends. The included curved tip syringe makes bleeding a snap as well as being brake fluid and solvent resistant. Finish your HydraStop unit with one of our chrome accumulator covers for that show quality finish.

HBA-1K	Hydraulic Brake Assist Install Kit	\$29.00
20-0038F	In-Line Filter, 3/8" lines, each	\$20.00
CP0105	Brake Bleeding Syringe, curved tip, each	\$5.00
45045	Prop Valve/Master Cylinder Adapter Fitting Kit	\$15.00
CP5100	Chrome Accumulator Cover, each	\$69.00



For more Master Cylinder options...

See page 269



For more Power Steering Pump options...

See page 287



CHEVROLET TRUCK

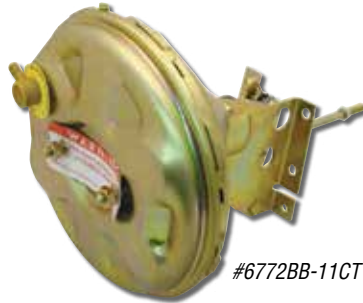
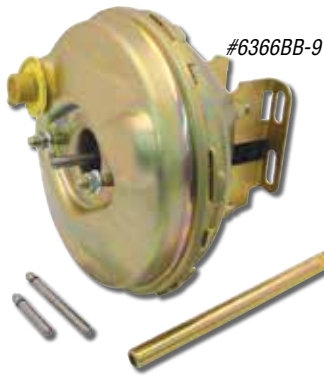

NEW!



NEW!



NEW!

OEM REPLACEMENT BRAKE BOOSTERS

Replace your original or upgrade to power with one of CPP's brake boosters. All boosters are brand new and are available in both brilliant gold cadmium plating or a production chrome (some also available in black coated). OE applications come with firewall bracketry and pedal linkage. All boosters come with a long and short pin for either deep or shallow master cylinders.

6366BB-9	1963-66, gold cad	\$169.00
6366BB-9C	1963-66, chrome	\$289.00
6772BB-11CT	1967-72, (with brackets) gold cad	\$225.00
6772BB-11CT-C	1967-72, (with brackets) chrome	\$345.00
11SRB-T	1967-72, (without brackets) gold cad	\$149.00
11SRB-TC	1967-72, (without brackets) chrome	\$249.00
7387BB-11D	1973-87, (with brackets) black	\$269.00
8893BB-9D	1988-93, 1/2 & 3/4 ton, 9" dual	\$269.00
8893BB-11D	1988-93, 1/2 & 3/4 ton, 11" dual	\$269.00
9499BB-11D	1994-99, 1/2 & 3/4 ton, 11" dual	\$269.00

BOOSTER CLEVIS

Replacement for the factory pedal clevis.



6772BC	1967-72, each	\$9.00
--------	---------------	--------

FIREWALL & BOOSTER BOOT



64031	1967-72 C10 Pedal Rod Boot, each	\$7.00
-------	----------------------------------	--------

LOOKING FOR MORE BRAKE BOOSTERS & MASTER CYLINDERS?



See the Universal Section - pages 265-270



BRAKE PEDAL BRACKETS

Whether you're looking to mount your brake pedal bracket on the frame or on the firewall, and if you're looking for manual or power applications, we've got what you need. Firewall units come in specific fit and universal applications (for universal applications, see page 265). They have a raw finish and come with the pedal arm (except for #4756MCA and #5559MCA). Pedal pads sold separately. Frame mount units come black powder coated. *Note: 1955-59 will work with original E-brake handle.* See page 266 for pedal pads.

4753FMB	1947-53 firewall power	\$149.00
CP632-BPB	1947-54 frame mount power	\$89.00
4756MCA	1947-54 frame mount manual	\$79.00
CP633-BPB	1955-59 frame mount power	\$89.00
5559FMB	1955-59 firewall power	\$149.00
5559MCA	1955-59 frame mount manual	\$79.00

MANUAL MASTER CYLINDER & BRACKET KIT

Upgrade your 1947-59 Chevy truck from a single reservoir to a Corvette-style dual reservoir master. Cylinder bracket and hardware included. Available for disc/drum and disc/disc applications.



4756MMK-2	1947-54, disc/drum, kit	\$219.00
4756MMK-4	1947-54, disc/disc, kit	\$219.00
5559MMK-2	1955-59, disc/drum, kit	\$219.00
5559MMK-4	1955-59, disc/disc, kit	\$219.00



OE FIT MASTER CYLINDERS

Original fit and finish, all brand new masters.

4751SMC	1947-51, each	\$89.00
5254SMC	1952-54, each	\$89.00
5559SMC	1955-59, each	\$89.00
M-90002	1960-62, w/ auto. transmission (2 bolt diagonal), each	\$89.00
M-90003	1963-66, w/ manual transmission (3 bolt mount), each	\$89.00
M-82017	1963-66, each	\$69.00
M-87002	1971-72, each	\$59.00

MUSTANG II IFS SYSTEM

Enjoy the comfort and benefits of having an independent suspension system in your early truck without paying the big prices of other kits. These kits come with crossmember, coil springs, spindles, 11-3/4" diameter rotor performance brakes, gas shocks, upper and lower control arms, new power rack & pinion, sway bar, forged hubs and our Big Bore™ calipers plus mounting hardware. Specify manual or power steering and stock or dropped spindles. Available in 4.5, 4.75, 5x5 or 5x5.5 and 6x5.5 lug patterns.

NEW POWER RACK, SWAY BAR & 11-3/4" ROTOR PERFORMANCE BRAKES INCLUDED!



Upgrade starting at **\$599/kit**



AIR BAG UPGRADE



COILOVER UPGRADE

Upgrade starting at **\$479/kit**



WILWOOD CALIPER UPGRADE

Upgrade starting at **\$200/kit**

NEW OPTION!

Available in black or red

E3739M2IFS-K	1937-39, Economy Mustang II kit	\$1,489.00
E4754M2IFS-K	1947-54, Economy Mustang II kit	\$1,489.00
E5559M2IFS-K	1955-59, Economy Mustang II kit	\$1,489.00
E3739M2-X	1937-39, Crossmember only	\$209.00
E4754M2-X	1947-54, Crossmember only	\$209.00
E5559M2-X	1955-59, Crossmember only	\$209.00
M2ABU-K	Air Bag Upgrade Kit	\$599.00
M2COK	Coilover Upgrade Kit	\$479.00
-WWB	Wilwood Caliper Upgrade Kit, black	\$200.00
-WWR	Wilwood Caliper Upgrade Kit, red	\$200.00

PERFORMANCE BRAKE PACKAGE FOR MUSTANG II O.E. WHEEL 5 & 6-LUG BRAKE KIT

These awesome wheel kits work with stock or drop Mustang II spindles has 11.75" rotors, forged aluminum hubs (lightweight and strong), Big Bore™ calipers, and will accept original wheels. Sold outright or as an upgrade to any of our independent front suspension Mustang II kits. Note: Spindles sold separately.



*Shown with optional upgraded rotors.

M2WBK-450	1947-87 Chevy Truck and other applications with 5x4.5 Mustang II Spindles, kit	\$499.00
M2WBK-475	1947-87 Chevy Truck and other applications with 5x4.75 Mustang II Spindles, kit	\$499.00
M2WBK-5	1947-87 Chevy Truck and other applications with 5x5 Mustang II Spindles, kit	\$499.00
M2WBK-5.5	1948-56 Ford Truck and other applications with 5x5.5 Mustang II Spindles, kit	\$499.00
M2WBK-6	1947-87 Chevy Truck and other applications with 6x5.5 Mustang II Spindles, kit	\$499.00
	*slotted cross drilled rotors upgrade, pair	\$75.00



DELUXE CHASSIS UPGRADE KIT

Are you building a show truck or just want to update your original suspension? Plan on adding tubular components and lowering your truck at the same time? This deluxe chassis kit allows you to finish off that frame and has those upgraded pieces that you're looking for. Kit includes: front and rear coil springs (your choice of front stock height, 1", 2" or 3" lowered and your choice of stock height, 3", 4" or 5" lowered rear) front and rear shocks, front and rear sway bars, front upper and lower Totally Tubular™ control arms, steering linkage kit (inner & outer tie rod ends, billet sleeves, idler arm and P/S pitman arm) 500 Series™ Power Steering Box (1963-66 kit also includes frame mount brackets for box), front shock support brackets, motor perches (small or big block), transmission cross member, drop center cross member, Totally Tubular™ trailing arms, rear tubular shock cross member, shock relocation kit, deluxe trac bar, lowering block kit, rear coil spring retainer kit and c-notch kit.



6366DCU-K	1963-66, kit	\$3,399.00
6770DCU-K	1967-70, kit	\$3,299.00
7172DCU-K	1971-72, kit	\$3,299.00
7382DCU-K	1973-82, kit	\$3,299.00
8387DCU-K	1983-87, kit	\$3,299.00

Add Disc Brakes... Choose from a variety of our brake packages to complete this suspension package.



See pages 5-9 for all available options.



See page 46 for all available options.

Add a Currie Rear End...

Complete Currie rear end assembly built especially to bolt right into your C10. Add it on to your Deluxe Chassis Upgrade kit now! We offer housing and axle kits, third members (standard and Posi) and brake kits to match.



Color powder coat shown for display purposes only, chassis comes plain finish.

Chassis shown with standard Mustang II IFS system, front sway bar, rear leaf kit, 9" drum brake, rear axle, brake booster, and master cylinder.
As shown \$9,199



Standard 11" Brakes



Complete Rear 4-Link Kit



Front 13" Brake Upgrade



Air Spring Upgrade



Coil-Over Retro Fit Kit



Mustang II I.F.S. System -
Includes crossmember, coil spring-shock towers. 1" tubular A-arms, spindles (stock height of 2" drop), new manual rack and pinion gear, 11" disc kit, black powder coated springs and painted shocks.



Custom I.F.S. System -
Tubular upper and lower A-arms, manual rack and pinion steering, billet aluminum coil-over shocks and anti-sway bar.

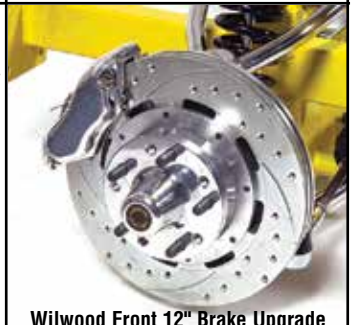

Wilwood Front 12" Brake Upgrade



Anti-Roll Bar Option



Rear 12" Rotor w/ Polished 4-Piston Caliper Brake Kit



Complete Rear Leaf Kit

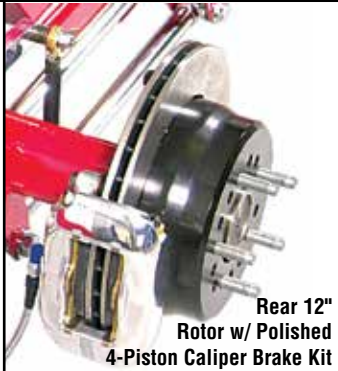

Rear 12" Rotor w/ Polished 4-Piston Caliper Brake Kit



Kick-Up Option



25 Gallon Aluminum Gas Tank Option



Frames are crated and ready for direct shipment to you

BASE AND COMPLETE CHASSIS

Classic Performance Products is now offering base and complete chassis for many popular car and truck applications.

Chassis feature boxed frame design and include Mustang II IFS crossmember, small block Chevy or Ford motor mounts, brake pedal assembly and rear shock crossmember welded in. Base chassis also includes control arms, coil springs, shocks, 2" dropped spindles with GM brakes in either 5x4.5 Ford or 5x4.75 GM lug pattern, manual rack & pinion, rear leaf spring kit and a rear 9" axle housing with axles.

Complete chassis also include: 3rd member (with choice of gears), rear drum brakes, brake booster and master cylinder, proportioning valve, brake light switch, front & rear brake hoses and steel hard lines all installed with fittings and plumbing connected.

With many upgrades available, you can customize the chassis to your exact specifications.



'55-'59 Chevy Stepped Rails



Kugel Complete 9" (IRS) Independent Rear Suspension System, please call for pricing and available options.

Kugel (IRS) Independent Rear Suspension System



Stock height spindle option now available for custom IFS chassis.

132-1245-00	1947-53 complete chassis	\$9,939.00
133-1240-00	1955-59 base chassis	\$8,234.00
133-1245-00	1955-59 complete chassis	\$9,939.00

UPGRADES:

313-3910-00	Power rack and pinion	\$100.00
412-4856-00	Rear anti-roll bar/ 4 link	\$302.00
600-6920-00	Stainless/AN brake lines	\$269.00
401-4241-00	Front shockwaves (custom IFS)	\$945.00
400-4420-00	Front air spring (Mustang II)	\$399.00
600-6917-03	12" rotor/polished caliper (custom IFS)	\$874.00
600-6918-03	13" rotor/polished caliper (custom IFS)	\$1,719.00
600-6923-00	13" rotor/polished caliper (Mustang II)	\$1,719.00
600-6930-00	Hi tech rear disc (GM caliper)	\$289.00
200-2920-00	Stock ht spindles (Mustang II only)	EXCHANGE
UG-M2WBK-6	6-lug brakes	\$499.00
UG-M2WBK-5	5x5 lug brakes	\$499.00
4753AGT-TCI	1947-53 Aluminum gas tank	\$499.00

CHEVROLET TRUCK



BASIC CHASSIS UPGRADE KIT

If you are planning a frame-off project, or just want to update your original suspension, this kit allows you to finish off that frame. Kit includes Mustang II IFS, rear leaf kit, booster kit and universal brake line kit. Please specify stock or drop spindles and GM 5x4.75 or Ford 5x4.5 brakes when ordering. *Not recommended for 6 cylinder.*

4754BCU-K	1947-54, kit	\$3,099.00
5559BCU-K	1955-59, kit	\$3,099.00



DELUXE CHASSIS UPGRADE KIT

Are you building a show truck or just want to update your original suspension? This deluxe chassis kit allows you to finish off that frame. Kit includes custom IFS, plain rear 4-link, booster kit and stainless steel universal brake line kit. When ordering, specify stock or drop spindles, your choice of through frame or bulkhead fitting and GM 5x4.75 or Ford 5x4.5 brakes. *Not recommended for 6 cylinder.*

4754DCU-K	1947-54, kit	\$4,199.00
5559DCU-K	1955-59, kit	\$4,199.00



*Show Package shown

**NOW INCLUDES
RIDE TECH
SINGLE ADJUSTABLE
SHOCK!**

*Shown with upgraded rotors and hoses.



#TCIWBK-6



Stock height spindle option now available for custom IFS chassis.

CUSTOM IFS

Our custom IFS is the ultimate front suspension system. Enjoy the smooth ride and handling of independent suspension and lower your truck 6". Our kits feature a one piece crossmember (caster and camber adjusted by means of an eccentric), 1" upper and 1-1/8" lower tubular arms with polyurethane bushings, new manual rack & pinion with tie rod ends, adjustable billet coil-overs with black powder coated springs, heavy duty forged steel spindles, GM calipers and 11" rotors. Sway bars sold separately. *Note: Will only work with V8 conversions. Ford kits come with 5x4.5 and Chevy kits come with 5x4.75 lugs. Ask about optional lug pattern upgrades. Not recommended for 6 cylinder.*

232-2202-00	1947-54, kit	\$2,999.00
233-2202-00	1955-59, kit	\$2,999.00

UPGRADES:

300-3910-00	Power rack and pinion	\$100.00
401-4241-00	Shockwave Air Spring kit	\$945.00
UG-TCIWBK-5	5x5 Upgrade	\$499.00
UG-TCIWBK-6	6x5.5 Upgrade	\$499.00



*Show Package shown



CHEVROLET TRUCK

*Shown with upgraded rotors and hoses.



#M2WBK-6

COIL SPRING FRONT END IFS

Enjoy the benefits of an IFS system without paying top dollar for the Custom IFS with one of our Coil Spring Front End IFS systems. The Coil Spring Front End IFS kits come with a weld-in crossmember and spring hats, tubular upper and lower control arms, screw in ball joints, 11" 5 rotors, GM calipers, your choice of 2" drop spindles, coil springs, shocks, manual steering rack and pinion with tie rod ends plain sway bar and all mounting hardware. Installation of this kit will yield a 2" to 4" drop depending on your choice of spindles. Please specify motor being used. *Note: Will only work with V8 conversions. Ford kits come with 5x4.5 and Chevy kits come with 5x4.75 lugs. Ask about our optional lug pattern upgrades. Not recommended for 6 cylinder.*

230-2354-00	1937-39, kit	\$2,295.00
231-2354-00	1940-46, kit	\$2,295.00
232-2354-00	1947-54, kit	\$2,295.00
233-2354-00	1955-59, kit	\$2,295.00

UPGRADES:

306-3910-00	Power rack and pinion	\$100.00
400-4420-00	Air spring kit	\$399.00
200-2920-00	Stock height spindles	Exchange
UG-M2WBK-5	5x5 Upgrade	\$499.00
UG-M2WBK-6	6x5.5 Upgrade	\$499.00



HEIDT'S
Hot Rod Shop, Inc.

NEW

HEIDTS MUSTANG II IFS SYSTEM

Heidts Mustang II Suspension kits come complete with crossmember, paintable tubular upper and lower full A-frame style control arms, 11" five lug rotors, bearings and seals, springs, shocks, stock spindles, GM calipers with brackets and pads, manual rack and pinion with tie rod ends and bushings, rubber spring cushions, spindle nuts w/washers, and all mounting hardware. Stabilizer bars are available for many applications. *Note: System painted for catalog purposes only.*

CX-305-E-K	1937-39, kit	\$1,899.00
CX-306-E-K	1940-46, kit	\$1,899.00
CX-307-E-K	1947-54, kit	\$1,899.00
CX-308-E-K	1955-59, kit	\$1,899.00

UPGRADES: (all require rack extensions)

MP-037-4	Rack extensions, manual	\$945.00
MP-039-4	Rack extensions, power	\$499.00
BX-603	1964-72 C-10 Heavy Duty	\$3,672.00
BX-660	1973-87 C-10 Heavy Duty	\$3,672.00
	Power rack and pinion	\$200.00



NEW

HEIDT'S
Hot Rod Shop, Inc.

HEIDTS HEAVY DUTY INDEPENDENT FRONT SUSPENSION

Looking for the ultimate suspension system to replace the original equipment? Look no further, Heidts has what you are looking for! Introducing their BOLT ON Heavy Duty Series Superide® II for 63-72 Chevy C-10s. Heidts Heavy Duty Series, is built tough. The one piece main crossmember is made of 7 gauge HRPO steel, internally gusseted just to make it that much stronger, and bolts directly in place of the original crossmember.

BX-603	1964-72 C-10 Heavy Duty	\$3,672.00
BX-660	1973-87 C-10 Heavy Duty	\$3,672.00



HEIDT'S
Hot Rod Shop, Inc.

NEW

HEIDTS SUPERIDE II IFS SYSTEM

Heidts SUPERIDE® II IFS System is the ultimate front suspension system. Enjoy driving with the smooth ride and good handling of independent suspension, and add to the value of your classic truck with a Heidts independent suspension system, the most popular suspension system in use today. Why? Because they are engineered right to work right!

All New! Not A Mustang conversion kit! Heidts SUPERIDE II IFS System uses a Mustang II spindle to allow for a front mount rack & pinion unit, this allows for easy engine installation. The upper control arms use threaded adjusters for the wheel alignment. These threaded adjusters, unlike eccentric adjusters, will never "slip" and lose alignment no matter how big a bump you hit. "Smooth" describes the ride: very low and highly steerable with no bumpsteer and built-in anti-dive. Installing the 3-piece crossmember is an easy operation. Combined with detailed instructions your installation will be as smooth as your ride with your new SUPERIDE II from Heidts. *Note: System painted for catalog purposes only.*

BX-212	1937-39, kit	\$1,899.00
BX-305	1940-46, kit	\$1,899.00
BX-306	1947-54, kit	\$1,899.00
BX-307	1955-59, kit	\$1,899.00

UPGRADES: (all require rack extensions)

MP-037-4	Rack extensions, manual	\$945.00
MP-039-4	Rack extensions, power	\$499.00
	Power rack and pinion	\$200.00



HEIDTS MUSTANG II IFS SYSTEM

Looking to add a Heidts crossmember with your economy Mustang II suspension kit? Then this kit's for you! Specify stock or drop spindle and manual or power steering.

HEIDT'S
Hot Rod Shop, Inc.

EM23739-HK	1937-39, kit	\$1,749.00
EM24046-HK	1940-46, kit	\$1,749.00
EM24754-HK	1947-54, kit	\$1,749.00
EM25559-HK	1955-59, kit	\$1,749.00



AIR SUSPENSION SYSTEMS BY RIDETECH - LEVEL 1



The Level 1 system features a pre-adjusted shock that is dialed in to provide a great ride quality and improved handling over stock. The Level 1 system is equipped with a manual RidePRO analog control system to save expense while still providing complete control over ride height. This is a great choice for improving ride quality at a low price point.

Included in this complete system: CoolRide Airsprings and brackets, Black Series shocks, and RidePRO analog controls 3 gallon single compressor.

11340109	1963-70 Truck, (Coil Over Suspension) kit	\$4,450.00
11330199	1963-72 Truck, (Air Suspension) kit	\$2,300.00
11460199	1963-72 Suburban, (Air Suspension) kit	\$2,300.00
11350109	1971-72 Truck, (Coil Over Suspension) kit	\$4,450.00



AIR SUSPENSION SYSTEMS BY RIDETECH - LEVEL 1



The Level 1 system features a pre-adjusted shock that is dialed in to provide a great ride quality and improved handling over stock. The Level 1 system is equipped with a manual RidePRO analog control system to save expense while still providing complete control over ride height. This is a great choice for improving ride quality at a low price point.

Included in this complete system: AirBar with Airsprings, Black Series front & rear shocks, and RidePRO analog controls 3 gallon single compressor.

11360199	1973-87 Truck, air suspension, kit	\$3,600.00
-----------------	------------------------------------	-------------------



AIR SUSPENSION SYSTEMS BY RIDETECH - LEVEL 2



Stepping up to our most popular Level 2 system will include upgraded aluminum adjustable shocks, as well as the RidePROe3 fully programmable electronic control system. The Level 2 system provides more adjustment and performance potential for both track use and ride quality. For anyone looking for a system that runs well right out of the box while leaving the opportunity for quick adjustments, we recommend this kit.

Included in this complete system: Front and Rear Airsprings, Upper and Lower StrongArms with Crossmembers, spindles, and RidePRO e3 controls 5 gallon dual compressor.

11340299	1963-70 Truck, (Air Suspension) kit	\$6,850.00
11340210	1963-70 Truck, (Coil Over Suspension) kit	\$4,650.00
11350299	1971-72 Truck, (Air Suspension) kit	\$6,850.00
11350210	1971-72 Truck, (Coil Over Suspension) kit	\$4,650.00



AIR SUSPENSION SYSTEMS BY RIDETECH - LEVEL 2



Stepping up to our most popular Level 2 system will include upgraded aluminum adjustable shocks, as well as the RidePROe3 fully programmable electronic control system. The Level 2 system provides more adjustment and performance potential for both track use and ride quality. For anyone looking for a system that runs well right out of the box while leaving the opportunity for quick adjustments, we recommend this kit.

Included in this complete system: CoolRide Airsprings and brackets, Upper and Lower StrongArms with Crossmembers & Airsprings, Master Series Single Adjustable front and rear shocks, and RidePRO e3 controls 5 gallon dual compressor.

11360299	1973-87 Truck, air suspension, kit	\$5,800.00
-----------------	------------------------------------	-------------------

CHEVROLET TRUCK



SUSPENSION

*Shown with optional upgraded calipers.



MODULAR™

ORIGINAL OFFSET SOS™ BIG BRAKE GRAND SLAM KIT

Looking to lower your truck and make it stop on a dime? CPP has the answer with our Modular™ Spindle Big Brake Grand Slam. At the heart of the kit is our Modular™ spindle 13" rotor twin 52mm piston caliper kit. This will improve your stop times tremendously from 60-0mph over stock! Also, the Modular™ spindle will bring your wheels in to combat any fender to tire clearance issues. Grand Slam kits include: spindles, 13" crossed drilled & gas slotted rotors, aluminum hubs, loaded calipers, caliper mount brackets, bearings, seals, spindle nuts, banjo bolts, rubber brake hoses and a booster, master cylinder, prop valve assembly, front and rear coils and shocks. *Specify drop for coil springs.

QUICK FACTS...	
STOCK/DROP	drop
ROTOR	13"
CALIPER	52MM (x2)
OFFSET	-250
MIN. WHEEL SIZE	17
BACKSPACING	factory

6366GSK-55213	1963-66, 13", (5x5), 5 lug	\$1,799.00
6366GSK-65213	1963-66, 13", (6x5.5), 6 lug	\$1,799.00
6770GSK-55213	1967-70, 13", (5x5), 5-lug	\$1,799.00
6770GSK-65213	1967-70, 13", (6x5.5), 6-lug	\$1,799.00
7172GSK-55213	1971-72, 13", (5x5), 5-lug	\$1,799.00
7172GSK-65213	1971-72, 13", (6x5.5), 6-lug	\$1,799.00

CHEVROLET TRUCK



MODULAR™

*Shown with optional upgraded rotors.

ORIGINAL OFFSET SOS™ GRAND SLAM KIT

Looking for a spindle and brake kit for your lowered truck that won't push your wheels out? We have it! CPP's modular 2" drop spindle and wheel kits for 1960-87 Chevy pickups. The CPP Modular™ Spindle offers many benefits available for the first time, installs easy without modifications, lowers your truck a full 2-1/2", offers adjustable steering stops, provides more fender to tire clearance. You can count on CPP for impressive quality, performance and price. Complete kits include: spindles, 12" rotors, loaded calipers, caliper mount brackets, bearings, seals, spindle nuts, banjo bolts, rubber brake hoses, ball joints, tie rod ends, adjusting sleeves and a booster, master cylinder, prop valve assembly, front and rear coils and shocks. *Specify drop for coil springs.

QUICK FACTS...	
STOCK/DROP	drop
ROTOR	12"
CALIPER	2.938
OFFSET	-250
MIN. WHEEL SIZE	15
BACKSPACING	factory

6366GSK-5D-MOD	1963-66, 12", (5x5), 5 lug	\$1,499.00
6366GSK-6D-MOD	1963-66, 12", (6x5.5), 6 lug	\$1,499.00
6770GSK-5D-MOD	1967-70, 12", (5x5), 5-lug	\$1,499.00
6770GSK-6D-MOD	1967-70, 12", (6x5.5), 6-lug	\$1,499.00
7172GSK-5D-MOD	1971-72, 12", (5x5), 5-lug	\$1,499.00
7172GSK-6D-MOD	1971-72, 12", (6x5.5), 6-lug	\$1,499.00

CALIPER COLOR UPGRADES:

POWDERCOATED SHOW CALIPERS

(-B) black, (-BLU) blue, (-R) red, or (-S) silver

4 Wheel.....\$200 Front or Rear only..... \$100

PRODUCTION FINISH CALIPERS

(-B) black or (-R) red Front or Rear..... \$55



*Shown with optional upgraded rotors.

DUST SHIELD INCLUDED

NEW SPINDLE DESIGN!



GRAND SLAM KIT

This kit includes stock or 2.5" dropped front spindles, bearings, loaded calipers, 12" rotors, brake hoses, master cylinder, power booster, prop-valve, four gas shocks, four lowered coil springs, inner and outer tie rod ends, custom adjusting sleeves, upper and lower ball joints, seals, spindle nuts, dust shields and dust caps. All necessary hardware is included. Tell us how much you want to drop the truck, and we'll send you the right coil springs to make it happen. May not work with factory drum brake wheels. If your truck has leaf springs, please inquire. *Note: Factory 6-lug applications had 7/16" dia. studs and 5 on 5-lug kits have 1/2" dia. studs.*

QUICK FACTS...	
STOCK/DROP	both
ROTOR	12"
CALIPER	2.938"
OFFSET	0; +.875"
MIN. WHEEL SIZE	15"
BACKSPACING	factory

6366GSK-5D	1963-66 Grand Slam Suspension/Brake (drop) Upgrade w/ 5-Lug Rotors, (5x5), kit	\$1,299.00
6366GSK-5S	1963-66 w/Stock Height (non-drop) Spindles, w/ 5-Lug Rotors, (5x5), kit	\$1,299.00
6366GSK-6D	1963-66 Grand Slam Suspension/Brake (drop) Upgrade w/ 6-Lug Rotors, (6x5.5), kit	\$1,299.00
6366GSK-6S	1963-66 w/Stock Height (non-drop) Spindles, w/ 6-Lug Rotors, (6x5.5), kit	\$1,299.00
6770GSK-5D	1967-72 Grand Slam Suspension/Brake (drop) Upgrade w/ 5-Lug Rotors, (5x5), kit	\$1,299.00
6770GSK-6D	1967-70 Grand Slam Suspension/Brake (drop) Upgrade w/ 6-Lug Rotors, (6x5.5), kit	\$1,299.00
6770GSK-5S	1967-70 w/Stock Height (non-drop) Spindles, w/ 5-Lug Rotors, (5x5), kit	\$1,299.00
6770GSK-6S	1967-70 w/Stock Height (non-drop) Spindles, w/ 6-Lug Rotors, (6x5.5), kit	\$1,299.00
	*slotted cross drilled rotors upgrade	\$75.00



DROP KITS

Now our most popular drop components are available in one complete kit. 1963-72 kits feature 1" front and 5" rear drop springs and shocks, drop spindles, shock relocater kit and deluxe trac bar. 1973-87 kits include either drop spindles, shackles and hangers for a 2 1/4" drop or drop spindles, front drop springs, rear c-notch and flip kit for a 4 1/6" drop. *Note: Drop spindles require disc brakes and use heavy 1/2 ton (1.25") rotors.*

6370BDK*	1963-70, kit	\$699.00
7172BDK*	1971-72, kit	\$699.00
7387D24-K	1973-87, 2 1/4" Drop Kit (does not include shocks)	\$289.00
7387D46-K	1973-87, 4 1/6" Drop Kit (does not include shocks)	\$399.00

* Deluxe bent track bar option also available.

Add "-UG" to any kit

for drilled/slotted rotors and stainless hoses:

+ \$200 for 4 Wheel

+ \$100 for Front or Rear only



CHEVROLET TRUCK



NEW!

DELUXE 2/4 DROP KIT

Our new DELUXE 2/4 kit includes 2" drop spindles, 2" shackles, and 2" hangers. Specify 1" or 1.25" rotor.

CP8898-24D 1988-98 C1500 Deluxe 2/4 Kit **\$289.00**

COMPONENTS

DT-100645	2" Drop Spindle, small spud	\$159.00
DT-100629	2" Drop Spindle, large spud	\$159.00
DT-62003	2" Drop Shackle	\$35.00
DT-62014	2" Rear Hanger	\$139.00



NEW!

STANDARD 2/4 DROP KIT

Our new STANDARD kit includes 2" drop coil, 2" drop shackles, and 2" hangers. Must use 17" or larger wheels.

CP9906-24S 1999-06 Silverado Standard 2/4 Kit **\$239.00**

COMPONENTS

DT-610220R	2" Drop Coil, standard cab	\$109.00
DT-610220X	2" Drop Coil, x-cab	\$109.00
DT-62003	2" Drop Shackle	\$35.00
DT-62023	2" Rear Hangers	\$149.00

STANDARD 2/4 DROP KIT (NOT SHOWN)

Our new STANDARD 2/4 kit includes 2" drop coil, 2" shackles, and 2" hangers. Specify engine/cab size.

CP8898-24S 1988-98 C1500 Standard 2/4 Kit **\$229.00**

COMPONENTS

DT-610520R	2" Drop Coil, standard cab	\$109.00
DT-610520X	2" Drop Coil, x-cab	\$109.00
DT-62003	2" Drop Shackle	\$35.00
DT-62014	2" Rear Hangers	\$139.00

STANDARD 3/4 DROP KIT (NOT SHOWN)

Our new STANDARD 3/4 kit includes 3" drop coil, 2" shackles, and 2" hangers. Specify engine/cab size.

CP8898-34S 1988-98 C1500 Standard 3/4 Kit **\$229.00**

COMPONENTS

DT-610530R	3" Drop Coil, standard cab	\$109.00
DT-610530X	3" Drop Coil, x-cab	\$109.00
DT-62003	2" Drop Shackle	\$35.00
DT-62014	2" Rear Hangers	\$139.00



NEW!

4/6 DROP KIT

Our new STANDARD kit includes 2" drop coil, C-Notch and 6" flip kit. Specify 1" or 1.25" rotor and engine/cab size.

CP8898-46 1988-98 C1500 4/6 Drop Kit **\$449.00**

COMPONENTS

DT-610520R	2" Drop Coil, standard cab	\$109.00
DT-610520X	2" Drop Coil, x-cab	\$109.00
DT-100645	2" Drop Spindle, small spud	\$149.00
DT-100629	2" Drop Spindle, large spud	\$159.00
DT-210607	6" Flip Kit with C-Notch	\$189.00

DELUXE 2/4 DROP KIT

Our new DELUXE kit includes 2" drop spindles, 2" drop shackles, and 2" hangers. Must use 17" or larger wheels.

NEW!



CP9906-24D 1999-06 Silverado Deluxe 2/4 Kit **\$299.00**

COMPONENTS

DT-100699	2" Drop Spindle	\$169.00
DT-62003	2" Drop Shackle	\$35.00
DT-62023	2" Rear Hangers	\$149.00

4/6 DROP KIT

Our new 4/6 Drop Kit includes 2" drop spindles, 2" drop coils, C-notch, and 6" flip kit. Please specify engine/cab size. Must use 17" or larger wheels.

NEW!



CP9906-24S 1999-06 Silverado Standard Kit **\$239.00**

COMPONENTS

DT-610220R	2" Drop Coil, standard cab	\$109.00
DT-610220X	2" Drop Coil, x-cab	\$109.00
DT-100699	2" Drop Spindle	\$169.00
DT-211033	6" Flip Kit with C-Notch	\$189.00



COMPLETE PERFORMANCE PACKAGE

Get a Complete Performance Package and tune up your chassis with some of the best upgrades for a great price! This package teams up all of the pieces that will convert your ride into a corner carver on the track and a pleasure to drive on the streets. Totally Tubular™ Control arms in the front and the rear, front and rear coil springs, front and rear performance sway bar, front and rear Black Magic™ performance tuned shocks, a quick ratio power steering box, 2" drop Modular™ disc brake spindles and also a drop center cross member that is designed for lowered applications for mounting the trailing arms are a part of this kit. Arms are available in gloss black or silver powder coat. Put a C.P.P. under your ride today!

6370CPP-K	1963-70 C10, with trailing arms, kit (shown)	\$2,699.00
7172CPP-K	1971-72 C10, with trailing arms, kit	\$2,699.00



PRO-TOURING KITS

CPP's Pro-Touring Kits provide the ultimate performance for an affordable price. Our kits are made in the USA with the quality you have come to expect from Classic Performance Products, Inc. Included with each kit is a front and rear sway bar, coil springs and gas shocks, front upper and lower Totally Tubular™ control arms, rear Totally Tubular™ trailing arms and drop center crossmember. These kits are not for leaf spring trucks.

TOTALLY TUBULAR™ COIL SPRING & SHOCK KIT

Get improved handling and ground clearance from our Tubular Complete Coil Spring and Shock Kit. Your choice of 1", 2" or 3" lowered front coils and 3", 4" or 5" lowered rear coils. Kit also includes complete front upper and lower Totally Tubular™ control arms in black or silver and all (4) Black Magic™ lowered performance shocks. Specify year, lowered stance and black or silver arms when ordering. Not for leaf spring trucks and #7387TCA-CSSK does not include rear coils or shocks.

6370PTK-1	1963-70, kit (shown)	\$2,269.00	6370TCA-CSSK	1963-70 C10, kit	\$1,059.00
7172PTK-1	1971-72, kit	\$2,269.00	7172TCA-CSSK	1971-72 C10, kit	\$1,059.00
			7387TCA-CSSK	1973-87 C10, kit	\$925.00

NOTE: ALL KITS ON THIS PAGE HAVE YOUR CHOICE OF 1", 2" OR 3" FRONT DROP COILS AND 3", 4" OR 5" REAR DROP COILS.

CHEVROLET TRUCK

#6372CSSK-D



COIL SPRING KITS

Our coil spring kits are available with your choice of stock height, 1" drop, 2" drop and 3" drop front coils and stock height 3" drop, 4" drop and 5" drop rear coils. For even bigger savings, we also offer a coil spring and shock kit. This kit includes front coils, rear coils and all four shocks. When ordering, please specify desired drop. Part #6372CSSK-D includes drop coils, shocks, shock relocation kit, adjustable track bar, coil spring retainers and hardware. Please specify preferred drop. *Note: Coils and trac bar come powder coated black.*

6372CSSK-D	1963-72, Deluxe drop, kit	\$479.00
6372CSSK	1963-72, Coil Spring & Shock (front & rear), kit	\$329.00
6372CSK	1963-72, Coil Spring (front & rear), kit	\$189.00



LOWERING & HANDLING PERFORMANCE KIT

If you want to lower your truck and gain handling performance, this is the perfect kit for you. Choose between 1", 2", 3" lowered front springs and 3", 4", or 5" lowered rear springs and we'll do the rest. Includes front (1-1/4" dia.) and rear (1-1/8" dia.) sway bars, drop springs and shocks, brackets, bushings, hardware and adjustable trac bar. *Note: Sway bars and coils come black powder coated.*

6572LHP-K	1965-72, kit	\$599.00
------------------	--------------	-----------------



5" DROP REAR SUSPENSION KIT

This kit contains the components required to drop the rear of your trailing arm C10 5". *Note: C-notch required on truck with 5" or lower rear coils, to provide proper rear end travel.*

6572RDK	1965-72, kit	\$329.00
----------------	--------------	-----------------



In our area?

Visit our showroom...

For directions and hours, see the inside front of this catalog or visit us online @ www.classicperform.com



COIL SPRINGS

High quality OE fit and finish stock height and lowered coil springs. Sold in pairs and come black powdered coated. Heavy duty coils are for Panels, Suburbans and trucks that will be used for towing. *Note: 4" or lower drop recommend C-notch.*

FCS6102-S	1963-87, front stock height, pair	\$95.00
FCS6102-1	1963-87, front 1" drop, pair	\$95.00
FCS6102-2	1963-87, front 2" drop, pair	\$95.00
FCS6102-3	1963-87, front 3" drop, pair	\$95.00
RCS603-S	1960-72, rear stock height, pair	\$105.00
RCS603-3	1960-72, rear 3" drop, pair	\$95.00
RCS603-4	1960-72, rear 4" drop, pair	\$95.00
RCS603-4HD	1960-72, rear 4" heavy duty drop, pair	\$125.00
RCS603-5	1960-72, rear 5" drop, pair	\$95.00



COIL SPRINGS

DT-610210R	1999-06 Silverado, 1" drop, V8, Std Cab	\$109.00
DT-610210X	1999-06 Silverado, 1" drop, V8, X-Cab	\$109.00
DT-610220R	1999-06 Silverado, 2" drop, V8, Std Cab	\$109.00
DT-610220X	1999-06 Silverado, 2" drop, V8, X-Cab	\$109.00
DT-610520R	1988-98 C1500, 2" drop, V8, Std Cab	\$109.00
DT-610520X	1988-98 C1500, 1992-98 Sub, 1995-99 Tahoe 2" drop, V8, X-Cab	\$109.00
DT-610530R	1988-98 C1500 3" drop, V8, Std Cab	\$109.00
DT-610530X	1988-98 C1500, 1992-98 Sub, 1995-99 Tahoe 3" drop, V8, X-Cab	\$109.00
DT-610110	1982-04 S10, 1" drop	\$99.00
DT-610120	1982-04 S10, 2" drop	\$99.00
DT-610130	1982-04 S10, 3" drop	\$99.00

REAR COIL RETAINERS

Whether installing new rear coils on your C-10 or looking for those finishing pieces for your restoration, this kit is what you need. Kit includes four retainers (they even have the welded nuts like the factory) and mounting hardware.



RCR-K	1960-72, kit	\$20.00
--------------	--------------	----------------

FRONT LOWERED COIL SPRINGS

High quality OE fit lowered coil springs. Sold in pairs and come silver powdered coat. Available in 1", 2" or 3" drop.



DT-610110	1982-03 S-10, 1" drop, pair	\$99.00
DT-610120	1982-03 S-10, 2" drop, pair	\$99.00
DT-610130	1982-03 S-10, 3" drop, pair	\$99.00



HOTCHKIS SPORT SUSPENSION ANTI-SQUAT BRACKET SYSTEM

Improve the cornering performance and traction of your 1963-72 C-10 with the Hotchkis Sport Suspension Anti Squat Bracket System. This kit includes precision laser cut, CNC bent brackets with 4 positions for tuning the trucks anti squat characteristics for improved launches, increased traction, and added power out of the turns. The kit is a direct bolt in system and comes complete with billet differential wedges for pinion angle changes. Finished in gloss black powder coat. *Note: This system only works on coil spring models. Also, will not work with #6372LDL.*

30390	1965-72, kit	\$309.00
--------------	--------------	-----------------

TECH GUIDES | INSTRUCTION SHEETS | MAGAZINE STORIES | & MUCH MORE!

www.ClassicPerform.com

CHEVROLET TRUCK



#6372TCA-UKB480



#6372TCA-UKS903



#6372TCA-LKB481



#6372TCA-LKS1014

TUBULAR CONTROL ARMS

CPP's quality upper and lower Totally Tubular™ control arms are welded for maximum strength and visual impact. The lower control arms have a helical stamped coil spring mount, just like they did from the factory, which secures the coil spring into the lower control arm. The coil mount has been improved to make installation even easier. The lower shock mount is incorporated into the stamped coil plate. This stamping is welded around its entire perimeter. All arms that contain cross shafts are preassembled with the cross shafts and pivot sleeves and have a safety feature that captures both sides of the bushing, unlike the originals that were only retained on the one side of the bushing under the head of the bolt. This unique feature allows full control and virtually no flex on the control arm when cornering. Arms are available in gloss black or silver powder coat. Includes cross shafts, bushings, ball joints and bumpstops. *Note: Lower arms will only work with end-link style sway bar.*

Totally
TUBULAR™



* Helical Stamping with coil index, just like the factory with Heli Arc welded mandrel bent D.O.M. tubing. Built with more ground clearance and designed to work with most after market products like air ride, coil overs, rack and pinion and big brakes.

* Self-lubricated and able to withstand temperatures up to 400 degrees, patented material bushing are silent and stronger than polyurethane or delron!

* Interlocking design cross-shaft captures both sides of bushing and allows virtually no flex on arm when cornering!

6372TCA-UKB480	1963-70, Upper, black, pair	\$327.00
6372TCA-UKS480	1963-70, Upper, silver, pair	\$327.00
6372TCA-UKB683	1971-72, Upper, black, pair	\$327.00
6372TCA-UKS683	1971-72, Upper, silver, pair	\$327.00
6372TCA-UKB903	1973-87, Upper, black, pair	\$327.00
6372TCA-UKS903	1973-87, Upper, silver, pair	\$327.00
6372TCA-LKB481	1963-70, Lower, black, (coil spring) pair	\$529.00
6372TCA-LKS481	1963-70, Lower, silver, (coil spring) pair	\$529.00
6372TCA-LAB481	1963-70, Lower, black, (air bag) pair (Note: will not work with coil springs)	\$529.00
6372TCA-LAS481	1963-70, Lower, silver, (air bag) pair (Note: will not work with coil springs)	\$529.00
6372TCA-LKB1014	1971-87, Lower, black, (coil spring) pair	\$529.00
6372TCA-LKS1014	1971-87, Lower, silver, (coil spring) pair	\$529.00
6372TCA-LAB1014	1971-87, Lower, black, (air bag) pair (Note: will not work with coil springs)	\$529.00
6372TCA-LAS1014	1971-87, Lower, silver, (air bag) pair (Note: will not work with coil springs)	\$529.00



STOCK-TYPE CONTROL ARMS

These factory-correct upper and lower front control arms are exactly what you're looking for. Both versions are precision engineered and stamped from heavy-gauge steel for superior strength and durability. All arms are coated for protection. Units come with cross shafts.

6372SCA-U	1963-72, upper, pair	\$199.00
6372SCA-L	1963-72, lower, pair	\$279.00



COMPLETE FRONT END KITS

CPP's POLYPLUS™ front end kits make it possible to achieve better than new performance for a modest price. All kits includes: upper and lower ball joints, inner and outer tie rod ends, tie rod adjusting sleeves, idler arm or idler arm bushing. 1973-87 truck applications also include upper and lower control arm bushings, and bump stops. Sway bar bushings and end links sold separately.



POLYPLUS:

6062SFK-PT	1960-62, kit	\$319.00
6364SFK-PT	1963-64, kit	\$249.00
6566SFK-PT	1965-66, kit	\$219.00
6770SFK-PT	1967-70, kit	\$289.00
7172SFK-PT	1971-72, kit	\$289.00
7382SFK-PT	1973-82, kit	\$289.00
8387SFK-PT	1983-87, kit	\$309.00

RUBBER:

7382SFK-R	1973-82, kit	\$269.00
8387SFK-R	1983-87, kit	\$289.00

**We Design It...We Make It...
You Benefit!**



Read more on our design and manufacturing facilities page 2

The best parts at the best price!

CHEVROLET TRUCK



See page 346
for specs and
dimensions

CPP NITROGEN GAS SHOCKS

Our nitrogen gas shocks are designed to enhance your car or trucks performance and provide quick response to road conditions. The 180 psi nitrogen gas cylinder was specifically built with lowered vehicles in mind to give a boost in cornering performance. The outstanding quality is backed with a lifetime warranty.

DT-4078GSS	1947-54, stock, front, each	\$49.00
DT-4039GSS	1947-54, lowered, front, each	\$49.00
DT-4809G	1955-59, lowered, front, each	\$49.00
CPP-4095G	1955-59, stock, front, each	\$39.00
CPP-4809G	1960-62, stock height, front, each	\$39.00
CPP-4052G	1963-87, stock height, front, each	\$39.00
CPP-4809G	1963-87, 1"-2" lowered, front, each	\$39.00
CPP-M1200GLL	1963-87, 3" lowered, front, each	\$39.00
DT-4248G	1947-54, stock, rear, each	\$49.00
DT-4078G	1947-54, stock lowered, rear, each	\$49.00
CPP-4163G	1955-59, lowered, rear, each	\$39.00
DT-4231G	1955-59, stock, rear, each	\$49.00
CPP-4163G	1960-72, stock height, rear, each	\$39.00
CPP-4095G	1960-72, 2"-4" lowered, rear, each	\$39.00
CPP-4052G	1960-72, 5" lowered, rear, each	\$39.00

RCD CLASSICS BILSTEIN SHOCK ABSORBERS



Bilstein gas shocks are made with seamless shock bodies, hardened chrome plated and polished shaft. Precision valving, and the highest quality seals. Improved ride, handling, and control, with Bilstein's lifetime warranty.

55-R110	1947-54, stock height, front, each	\$89.00
55-R108	1947-54, lowered, front, each	\$89.00
55-R145	1957-59, stock height, front, each	\$89.00
55-R068	1957-59, lowered, front, each	\$89.00
55-R068	1960-62, stock height, front, each	\$89.00
55-R033	1963-87, stock height, front, each	\$89.00
55-R111	1947-54, stock, rear, each	\$89.00
55-R109	1947-54, lowered, rear, each	\$89.00
55-R146	1955-59, stock, rear, each	\$89.00
55-R145	1955-59, lowered, rear, each	\$89.00
55-R148	1960-62, stock height, rear, each	\$89.00
55-R042	1963-72, stock height, rear, each	\$89.00



RIDETECH Q SERIES SHOCKS

Monotube design allows large piston for superior oil control (which increases ride quality and handling performance). Performance is optimized and uses fewer components than a twin tube design. There are the RQ series and are non-adjustable. Applications designed for stock height springs.

22079850	1950-55, front, each	\$125.00
22049841	1962-87, front, each	\$125.00
22099854	1950-55, rear, each	\$125.00
22089861	1963-72, rear, each	\$125.00
22099841	1973-87, rear, each	\$125.00



NEW

SHOCKS

DT-4241G	1999-06 Silverado, rear	\$49.00
DT-4080G	1999-06 Silverado, front	\$49.00
DT-4173G	1999-06 Silverado, 4/6 drop kit, rear	\$49.00
DT-4231G	1988-98 C1500, rear	\$49.00
DT-4078G	1988-98 C1500, front	\$49.00
DT-4163G(L)	1988-98 C1500, 4/6 drop kit, rear, left	\$49.00
DT-4095G(R)	1988-98 C1500, 4/6 drop kit, rear, right	\$39.00



NEW

2" DROP SHACKLES

DT-62001	1973-87 C10, 1999-06 Stepside, 1994-99 Sub	\$45.00
DT-62003	1988-06 GM Std/Ex Cab, 1995-99 Tahoe	\$35.00
DT-62004	1992-94 Suburban	\$45.00

NEW



2" REAR HANGERS

DT-62012	1973-87 C10	\$149.00
DT-62014	1988-98 C1500	\$139.00
DT-62024	1992-94 Suburban	\$139.00
DT-62026	1995-99 Suburban	\$159.00
DT-62025	1995-99 Tahoe	\$149.00
DT-62023	1999-06 Silverado (Will not work w/8-rivet longbed)	\$149.00



NEW

6" FLIP KIT WITH C-NOTCH

DT-210607	1988-98 C1500, 6" drop	\$189.00
DT-210607	1973-87 C10, 6" drop	\$189.00
DT-211033	1999-06 Silverado, 6" drop	\$189.00



#4754FSBK



#5559FSM

FRONT SHOCK MOUNTS

Our front shock mount kits are designed to be used in conjunction with our power steering kit (part #4759PSK). The upper bracket mounts on the frame and the lower bracket located off the u-bolts. Kits include all hardware and templates needed to make this a quick and easy install. Brackets available separately or in a kit.

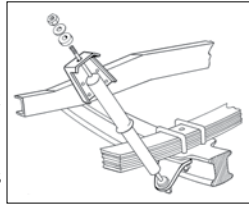

4754FSB-L	1947-54 lower front bracket, pair	\$38.00
4754FSB-U	1947-54 upper bracket, (front or rear) each	\$29.50
4754FSBK	1947-54 front bracket (incl. upper & lower shock mounts), kit	\$85.00
5559FSM	1955-59, kit	\$59.00

FRONT UPPER SHOCK BRACKETS

Designed for trucks with air-bags these brackets provide a sturdy anchor point for your front shocks. Brackets mount to top of the frame. Right and left brackets and mounting hardware included in kit.
Note: Requires longer shocks.



6072FUSB	1960-87, kit	\$39.00
-----------------	--------------	----------------

FRONT & REAR SHOCK SUPPORT BRACKET

A common problem with these GM trucks is the area where the front shock mounting studs bolts to the frame cracks. These support brackets help prevent the shock absorber stud from damaging the frame by enhancing the studs strength. Includes left and right sides.



6372FSRB	1963-87, front, pair	\$29.00
7387RSRB	1973-87, rear, pair	\$29.00



REAR SHOCK RELOCATOR BRACKETS

These useful pieces will help to put your rear shocks into the proper position and at the correct angle when lowering your truck. Recommended for 4" or 5" drops. *Note: Will not work on C-20.*

6372SRK	1963-72, kit	\$59.00
----------------	--------------	----------------



#CP4-2



REAR LOWERING BLOCK KITS & U-BOLTS

This is an easy and inexpensive way to lower your truck without affecting ride quality. Kits include aluminum blocks and new u-bolts. Kit comes with bare steel u-bolts and bare aluminum blocks.

CP4-5	1960-72, 1/2" drop, kit	\$69.00
CP4-1	1960-72, 1" drop, kit	\$69.00
CP4-15	1960-72, 1-1/2" drop, kit	\$69.00
CP4-2	1960-72, 2" drop, (not recommended for 15" wheels), kit	\$69.00
6072RUB-S	1960-72, stock length (9"), pair	\$49.00
6072RUB	1960-72, extended length (10"), pair	\$49.00



#4055UBK



#5559UBK-R

OE REPLACEMENT SQUARE TOP U-BOLT KITS FOR 1940-59 CHEVY TRUCKS



Complete front kit includes all 4 u-bolts, nuts and washers to assemble the axle properly to your leaf springs. Works with both stock and drop axle applications and with multi-leaf springs.

4055UBK	1940-55 (1955 1st Series), front, each	\$29.00
5559UBK-R	1955-59, rear, each	\$29.00

BLOCKS WITH 4° BUILT-IN SHIMS

These blocks will lower your truck and correct you're the pinion angle 4 degrees. This allows you to properly correct pinion angle without having to buy additional shims. Having the right driveline angles is a must; an incorrect pinion angle will cause drive shaft/U-joint vibration at highway speeds.



CP39026	1960-72 C10, .5", pair	\$80.00
CP39027	1960-72 C10, 1.0", pair	\$80.00
CP39028	1960-72 C10, 1.5", pair	\$80.00
CP39029	1960-72 C10, 2.0", pair	\$80.00

CHEVROLET TRUCK



UPPER & LOWER CONTROL ARM CROSS SHAFT KITS

Cross shafts are an essential components of your front suspension. Without them you aren't going anywhere. OEM replacement for this high wear item kit includes one shaft with grease seals and end caps, or bushings.

6062UCS	1960-62, upper, each	\$54.00
FA538	1963-72, upper, each	\$39.00
6062LCS-L	1960-62, left lower, (also fits 1963-64 C-20) each	\$89.00
6062LCS-R	1960-62, right lower, (also fits 1963-64 C-20) each	\$89.00
FA1142	1963-72, lower, each	\$49.00
FA1017	1963-72, upper - 3/4 ton, each	\$39.00
FA1178	1973-87, upper, each	\$55.00
FA9016	1973-87, lower, each	\$89.00



UPPER & LOWER BALL JOINTS

Replacing the ball joints on your front end helps to reduce steering "slop" and makes your car much safer to drive. Meet OE specification. Direct replacement that requires no modifications. Boots and hardware included.

FA548	1960-62, upper, each	\$39.00
FA327	1960-62, lower, each	\$39.00
FA480	1963-70, upper, each	\$19.00
FA481	1963-70, lower, each	\$25.00
FA680	1963-70, lower, 3/4 & 1 ton, each	\$35.00
FA683	1971-72, upper, each	\$39.00
FA903	1973-87, upper, each	\$25.00
FA1014	1971-87, lower, each	\$25.00
FA997	1971-82 C-20, lower, each	\$29.00
FA681	1971-83 C-20, upper, each	\$29.00

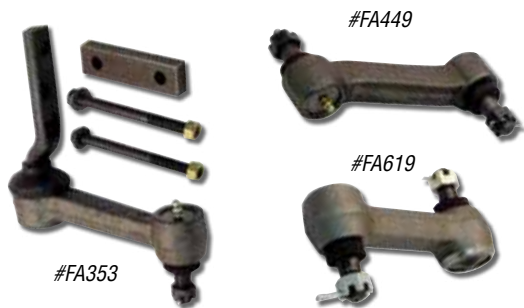

IDLER ARMS

The idler arm is a very important part of any steering system. A worn idler arm can cause tire wear and play in the steering system.

FA449	1960-62, each	\$69.00
FA353	1963-66, each	\$49.00
FA619	1967-82, each	\$39.00



MANUAL AND POWER STEERING PITMAN ARMS

Our replacement pitman arms are made to factory GM specs. Replacing a worn pitman arm will help reduce play in the steering system.

4759PA-PS	1947-59, standard, for basic p/s kit, each	\$59.00
4759PA-PR	1947-59, reversed (for lowered trucks), for basic p/s kit, each	\$59.00
5559PA-T	1955-59, Toyota or 400 Series™, each	\$59.00
FA556	1960-66, manual steering, each	\$69.00
FA626	1967-72, manual steering, each	\$69.00
FA694	1967-72, power steering (also 1960-66 p/s conversion), each	\$39.00
FA917	1973-86, manual steering, each	\$69.00
FA918	1973-86, power steering, each	\$69.00



CONTROL ARMS BUSHINGS

Whether you're doing an original rebuild or you want to tighten up your suspension we have the bushings for you. Our POLYPLUS™ bushings offer better handling and are impervious to the elements. Kits come with upper and lower control arm bushings.

3-3161G	1973-87, POLYPLUS™, set	\$65.00
----------------	-------------------------	----------------



TIE ROD ENDS

Replacing the tie rod ends on your front end greatly reduces steering "slop" and makes your car much safer to drive. Includes all hardware and dustboots.

4754TR-HD	1947-54, 1" diameter Tie Rod, each	\$69.00
4754TRK	1947-54, Tie Rod & Ends, kit	\$115.00
4759TRE	1947-59, Tie Rod Ends, new style, pair	\$49.00
5559TR-HD	1955-59, 1" diameter Tie Rod, each	\$69.00
5559TRK	1955-59, Tie Rod & Ends, complete	\$115.00
ES323L	1960-64, outer, 5/8-18 4" left, each	\$22.00
ES350L	1965-70, outer, 5/8-18 7.19" left, each	\$22.00
ES415R	1971-72, outer, 11/16-18 6.36" right, each	\$19.00
ES631	1960-62, inner, 5/8-18 8.66" right, each	\$29.00
ES678	1963-64, inner, 5/8-18 6.66" right, each	\$29.00
ES370R	1965-70, inner, 5/8-18 7.19" right, each	\$19.00
ES403L	1971-72, inner, 11/16-18 8.79" left, each	\$19.00
ES409R	1973-87, outer, 11/16"-18" LH, each	\$19.00
ES409L	1973-87, inner, 11/16"-18" RH, each	\$19.00

TIE ROD ADJUSTING SLEEVES

Stock replacement parts that meet OE specs. New adjusting sleeves will take the hassle out of doing a front end alignment. Sold individually, two required.



ES312S	1960-64, 5/8-18 thread, 8-11/16" length, each	\$15.00
ES350S	1965-70, 5/8-18 thread, 6" length, each	\$12.00
ES2004S	1971-87, 11/16-16 thread, 4-3/4" length, each	\$15.00



BILLET ALUMINUM TIE ROD SLEEVES

Our exclusive design is perfect for those who are looking for a custom look and appreciate the small details. Made from 6061 T6 aluminum. Sold in sets with three different finishes available, -AR (brushed) -AB (black) -AP (polished) includes jam nuts. Add R, B or P to end of part number for desired finish.

ES312SP-A	1960-64, 5/8-18, pair	\$69.00
ES350SP-A	1965-70, 5/8-18, pair	\$69.00
ES2004SP-A	1971-87, 11/16-18, pair	\$69.00
CP4SC-SA	5-1/4", custom (for disc brake conversions), pair	\$69.00



COMPLETE STEERING LINKAGE KITS

All main wear parts for your steering linkage can now be found in a full kit. Available for all 1963-87 C-10 trucks, our steering linkage kits come complete per application (without centerlink). Our kits include the proper inner tie rods, outer tie rods, adjusting sleeves, pitman arm and idler arm all in one kit! All kits are set up for power steering applications.

6770SLK-CP-C10	1967-70, C-10 for original or 500 Series™, kit	\$209.00
7172SLK-CP-C10	1971-72, C-10 for original or 500 Series™, kit	\$199.00
7382SLK-CP	1973-82, C-10 for original or 500 Series™, kit	\$199.00
7387SLK-CP-UG	1973-82, C-10 for original or 500 Series™, kit	\$199.00
8387SLK-CP	1978-87, C-10 for original or 500 Series™, kit	\$199.00
CT6364SLK-CP	1963-64, C-10 for original or 500 Series™, kit	\$239.00
CT6566SLK-CP	1965-66, C-10 for original or 500 Series™, kit	\$219.00

How it all began...



Read about the CPP Story on page 2



#CPP7423

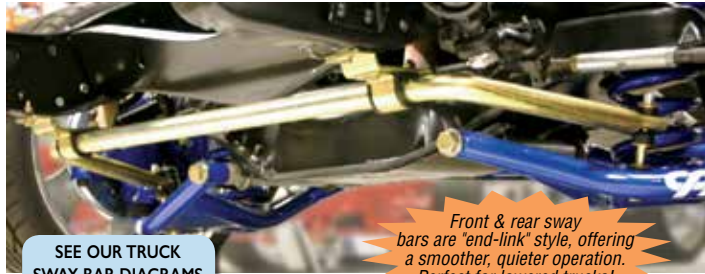

SEE OUR TRUCK SWAY BAR DIAGRAMS IN THE TECH SECTION - PAGE 341

Front & rear sway bars are 'end-link' style, offering a smoother, quieter operation. Perfect for lowered trucks!



#CP883U



#CPP7401-TA



#CPP12030

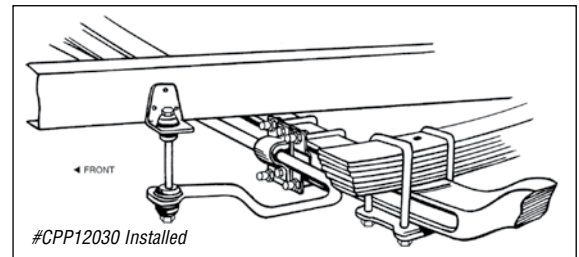

#CPP12030 Installed

STOCK SUSPENSION SWAY BARS

Sway bars are the key to having a great handling vehicle. They reduce body roll and help control over steer and under steer in corners. Kits come complete with sway bar, poly bushings, mounting brackets and all necessary hardware. Black powder coated finish. *Note: #CP169 will not work with TCI rear leaf kits.

FRONT:

CP179	1947-54, 1-1/8", kit	\$149.00
CPP12030	1955-59, 1", kit (will work with stock or drop axle)	\$139.00
CPP12030FBM	1955-59, 1", with billet mounts, kit	\$189.00
CPP7423	1963-87, 1-1/4", kit	\$139.00
CPP7423FBM	1963-87, 1-1/4" with billet mounts, kit	\$189.00
CP739U	1982-01 S-10	\$159.00

REAR:

CP169*	1947-59, kit	\$169.00
CPP7401	1960-72, Coil Spring, 1-1/8", kit	\$139.00
CPP7401-TA	1960-72, Coil Spring, with CPP tubular trailing arms, kit	\$179.00
CP7402	1960-72, Leaf Spring, 7/8", kit	\$149.00
CP369U	1982-98 S-10	\$159.00

FRONT SWAY BAR BRACKETS

These lowered front sway bar brackets will provide more ground clearance. Recommended for trucks lowered 3" or more. (Trucks with air bags use stock brackets.)



6372LSB	1963-87, Lowered, pair	\$24.00
6372SSB	1963-87, Stock, pair	\$24.00



NEW

SWAY BAR MOUNTING KIT

Already have a CPP sway bar and need to mount it to our tubular trailing arms? This kit will do the trick!

TTA-SBIK	1960-72, C-10, with CPP tubular arms and CPP sway bar, kit	\$49.00
----------	--	---------



#RBM-SK



#RBM-DK

#FBM25

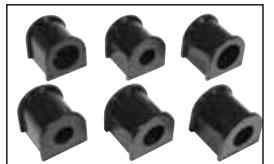

All sway bar diameters available

BILLET ALUMINUM SWAY BAR MOUNTS

For the ultimate in looks and longevity when pounding your street machine on and off the track, upgrade to these billet sway bar mount bracket kits. They feature greasable poly bushings and are available in a brushed machine, black or polished finish. Specify finish and diameter of sway bar.

FBM25	Front, pair	\$69.00
RBM-SK	Rear, Standard kit	\$89.00
RBM-DK	Rear, Deluxe kit	\$129.00



FRONT DROP AXLE

Get that I.F.S. look without the high cost. Lowers your truck 2-3" while retaining stock suspension travel. 2" seamless steel tubing with CNC machined ends. Chevy axles require tie plates (#4754DA-TP or #5559DA-TP) and king pins (#K484) and it is recommended to use tie rod ends (#4759TRE). *Caution: Using lowered leaf springs may result in bump steer. Drop axles ships O/S; additional freight charges apply.*

4754DA	1947-54, each	Inquire
5559DA	1955-59, each	Inquire

DROP AXLE TIE PLATES

For use when installing our 3" drop axle onto your 1947-59 Chevy truck. Sold separately; two required.



4754DA-TP	1947-54, each	\$8.00
5559DA-TP	1955-59, each	\$8.00

KING PIN SET

Quality replacements includes hardened steel pins, spacers and hardware. Recommended when adding drop axle. Works with stock or drop axle.



K484	1947-59, set	\$55.00
-------------	--------------	----------------

DRAG LINK REPAIR KIT

Avoid the high cost of replacing your tie rod ends with our OEM tie rod end repair kit. Includes springs, pins, seals and caps.



4759DLR-K	1947-59, kit	\$35.00
------------------	--------------	----------------

DRAG LINK 1/2, 3/4 & 1 TON

Original drag link mounts between steering box pitman arm and steering arm on driver side spindle.



4752DL	1947-52, each (shown)	\$225.00
5559DL	1955-59, each	\$79.00
5559DL-K400	1955-59, Custom Drag Link for 400 Series™ Conversion (see pg 49)	\$59.00



#4754SHK-F



#5559SHK-F

FRONT SPRING PIN & SHACKLE KITS

Quality replacements for your worn or corroded pins and shackles.

4754SHK-F	1947-55 front, kit	\$99.00
5559SHK-F	1955-59 front, kit	\$99.00



#4759RBH-KDI

ROLLER BEARING HUB UPGRADE KIT

CPP's new replacement forged aluminum hubs with new studs and installed bearing races are stronger and safer than any hub on the market to date. Our kit is also 2 lbs. lighter for added performance and fuel efficiency. A perfect fit for today's modern wheels and tires and any type of brake upgrade (can be used on 1947-59 Chevy Trucks with slip-over style disc brake rotors). Kit comes complete with two new 6 lug forged aluminum hubs, inner and outer bearings and races, wheel studs (drum brakes), wheel hub seals, hub caps, hub washers, grease caps and cotter pins.

4759RBH-KDI	1947-59, for disc brakes (does not include studs), kit	\$189.00
4759RBH-KDR	1947-59, for drum brakes, kit	\$215.00

PERFORMANCE ROLLER BEARING KIT

Convert your original ball bearings to modern tapered roller bearings. Tapered bearings disperse heat better and can deal with today's grooved roads and modern wheels and tires much better than the original ball type. New and improved seal! Highly recommended for use with the 6-lug disc brake conversion kit.



4759RBK	1947-59 Roller Bearing Kit	\$95.00
6064	Seal only, each	\$9.00



BODY MOUNT BUSHING KIT

This complete kit includes both upper and lower body mount "donuts" in our exclusive POLYPLUS™ graphite polyurethane.



3-4137G	1963-66, kit	\$69.00
3-4108G	1967-72, kit	\$59.00
3-4107G	1967-72, 4x4, kit	\$69.00
3-4149G	1967-72 Suburban, kit	\$129.00
3-4110G	1969-72 4x4 Blazer, kit	\$95.00
3-4109G	1973-80, kit	\$69.00
3-4116G	1981-87, kit	\$69.00



*Upgraded kit shown



TOTAL COST INVOLVED REAR 4-LINK SUSPENSION KIT

Upgrade your rear leaf spring suspension to a fully adjustable 4-link suspension with one of these kits. These kits help to improve handling and ride quality and allows for better weight transfer which improves traction. Kits will allow the rear end to be lowered up to 4" in some applications and most have 3 different settings for height. Kits include coil over shocks, crossmember member, 4 bars, mounting bracketry and hardware. Some kits contain drive shaft loop. All truck kits include trac bar. Some kits available with chrome or stainless bars. Air bag kits also available. *Note: Works with 3" axle tubes.*

532-5102-00	1937-53, plain bars, kit	\$1,063.00
532-5102-02	1937-53, stainless steel bars, kit	\$1,729.00
532-5120-00	1937-53, air bag, plain bars, kit	\$1,229.00
532-5120-02	1937-53, air bag, stainless steel bars, kit	\$1,951.00
532-5102-54	1954-55, 1st Series, plain bars, kit	\$1,063.00
532-5120-54	1954-55, 1st Series, air bag, plain bars, kit	\$1,229.00
533-5102-00	1955-59, plain bars, kit	\$1,063.00
533-5102-02	1955-59, stainless steel bars, kit	\$1,729.00
533-5120-00	1955-59, air bag, plain bars, kit	\$1,229.00
533-5120-02	1955-59, air bag, stainless steel bars, kit	\$1,951.00

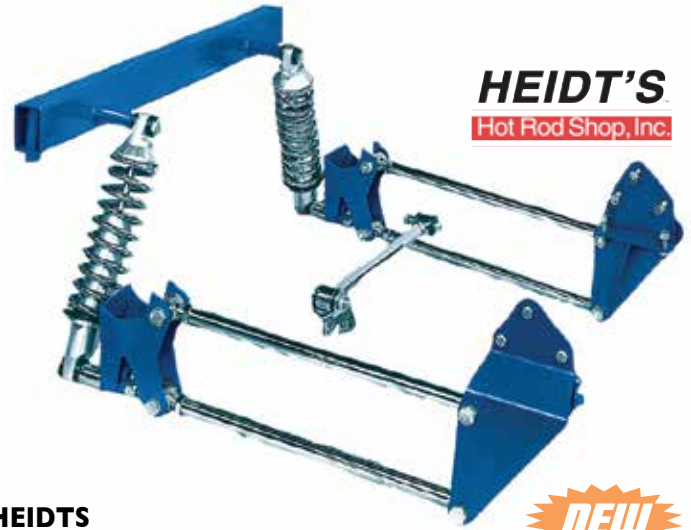

HEIDT'S
Hot Rod Shop, Inc.



HEIDT'S REAR 4-LINK SUSPENSION KIT

A 4 link provides control of the axle during suspension cycling and to locate the axle under the vehicle. The most common 4 link is used with panhard bar. This is found in many cars and pickup trucks. The 4 link for a solid axle has a few variations such as the triangulated 4 link and the Parallel 4 link.

Typically each arm has a spherical joint or rubber bushing at each end. Consequently they react to loads along their own length, in tension and compression, but not in bending.

In a solid axle suspension the upper arms may have an angle of at least 45 degrees between them, to prevent the axle from moving from side to side while allowing the axle to articulate and move freely up and down.

In a solid axle the lower arms control forward and backward motion, the upper arms control forward and backward rotation. This rotation is present under acceleration and braking.

Kit includes bars, brackets, coil-over crossmember. Coil-over 4-Link rear suspension provides the best ride for any classic truck. These kits attach directly to the stock frame rails. The adjustable axle brackets let you set ride height in one of three positions. A bolt-in upper crossmember for coil-overs is included.

RB-108	1947-53, kit	\$686.00
RB-109	1954-55, kit	\$686.00
RB-110	1955-59, kit	\$686.00

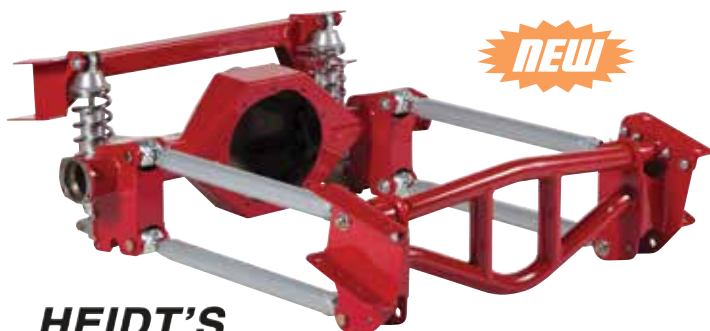

HEIDT'S
Hot Rod Shop, Inc.

HEIDT'S BOLT-IN HEAVY DUTY 4-LINK SUSPENSION KITS

Update the ride and handling of your 1967-72 C-10 with a new Heidts® 4-Link Kit. Kit features a 64" Track Width, Adjustable Ride Height, Double Adjustable Link Tubes, Adjustable 3 Position Pan Hard Bar, 1" Rod Ends, Billet Aluminum Shock Mounts, Optional Fabricated Housing and a Built In Drive Shaft Loop. Our 4-link kit has been made to fit factory coil spring trucks, if your truck came with factory leaf springs, you will need extra fabrication to make 4-link kit fit.

RB-112	1967-72, with axle brackets, kit	\$3,110.00
RB-114	1973-87 C-10, with brackets, kit	\$3,110.00



#6372TRS-K

THIS KIT IS IDEAL WHEN LOWERING 4" OR MORE!



*Note: Billet support bearing and mounting bracket sold separately.

REAR SUSPENSION KIT



Looking for a kit that has the rear end items that you need with one part number? CPP has got you covered with these rear suspension kits. Our Totally Tubular™ trailing arms are made from heavy duty gauge tubing and utilize a patented non-squeak self lubricating bushing that will never need to be greased and will outlast any material on the market. #6372TRS-K comes with trailing arms, crossmember, c-notch kit, shock relocater kit, drop block kit, lowered coil springs and lowered shocks. Specify height of coils and blocks when ordering. #7387TAC-A does not include coils, shocks or drop block kit and retrofits stock leaf springs. Available in black or silver powdercoat. *Note: Coils are black powder coat.*



Self-lubricated and able to withstand temperatures up to 400°, patented material bushings are silent and stronger than polyurethane or Delron.



CPP Heavy Duty Totally Tubular™ Trailing Arms utilize all factory hardware.



Provisions for mounting factory or CPP disc brake emergency cables.

6372TRS-K	1963-72, kit	\$1,379.00
6372TRS-AK	1963-72, (with air) kit	\$1,599.00
7387TAC-A	1973-87 - conversion kit (not shown)	\$1,199.00



NEW

REAR TRAILING ARMS



Replace those worn out trailing arms with new original replacement or CPP Totally Tubular™ arms. Original replacements come with rubber bushings. Totally Tubular™ arms are a stronger alternative to the factory arms and come with our patented bushings that are self-lubricating and will outlast any material on the market. OE stamped also available.

6072TTA-B	1960-72 C10, Totally Tubular™, black, pair	\$599.00
6072TTA-S	1960-72 C10, Totally Tubular™, silver, pair	\$599.00
6072STA-K	1960-72 C10, stamped, pair	\$449.00

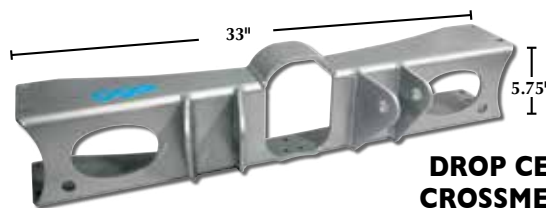

DROP CENTER CROSSMEMBER

Specially designed for trucks with a 4" or more drop. This crossmember is made from 1/4" thick laser cut steel plate, the hoop design eliminates drive shaft interference on slammed trucks. The exhaust passages allow you to tuck your 3" dual exhaust up out of the way. It bolts up in the stock location and includes trailing arm mounts. No cutting or welding is required. Grade 8 hardware included and comes with a silver powdercoat finish. *Note: Works with one- or two-piece driveline pickups (two-piece driveline pickups require #CPSBB, shown below).*

6372LDL-S	1963-72, silver, each	\$199.00
6372LDL-B	1963-72, black, each	\$199.00

REAR SHOCK CROSS MEMBER



Complete that custom tubular look when installing CPP Tubular Trailing Arms on your truck. Also a great way to add a shock crossmember when converting from leaf to coil springs.

6372RTSC-S	1963-72, silver, each	\$129.00
6372RTSC-B	1963-72, black, each	\$129.00

CARRIER BEARING BRACKET

This bracket is required when using a two-piece drive shaft and carrier bearing with CPP's Drop Center Crossmember (#6372LDL). Bracket is black finish.



CPSBB	1963-72, each	\$22.00
-------	---------------	---------



REAR FRAME C-NOTCH KIT

Give your truck 3" of added rear suspension travel with one of our rear C-notch kits. The 1947-59 Chevy truck weld into place, the 1960-72 C-10 kits bolt in. The heavy duty kit uses 3/8" material and is 1/8" thicker than the standard version. Heavy duty is ONLY recommended for towing applications. *Note: C-notch is required on 1963-72 trucks lowering 4+."*

4753CNK	1947-53, kit	\$59.00
5455CNK	1954-55 1st series, kit	\$59.00
5559CNK	1955-59 2nd series, kit	\$59.00
6372CNK	1963-72, kit	\$119.00
6372CNK-HD	1963-72, heavy duty, kit	\$179.00
7387CNK	1973-87, kit	\$109.00

NEW!

CHEVROLET TRUCK

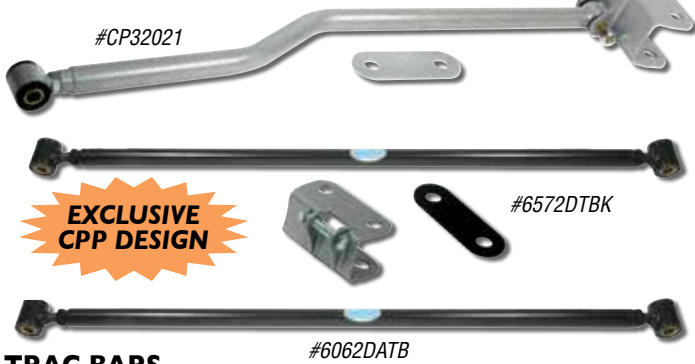

**EXCLUSIVE
CPP DESIGN**

TRAX BARS

These dual adjustable bars are designed for lowered vehicles and will allow for the rear to be lowered and still keep proper alignment of the rear end and allow you to make adjustments on the truck. Our adjustable units will adjust to the correct length to improve your vehicle's handling ability and take full advantage of your lowered center of gravity. Adjustable trax bars have double adjustment with left hand and right hand threads to allow ease of installation. Deluxe trax bars connect from the trailing arm of your truck to the frame, tying both sides of the truck together for strength. #CP32021 allows for clearance of large aftermarket differential covers.

6062DATB	1960-62, dual adjustable, 33.5", each	\$59.00
6062DTBK*	1960-62, deluxe, kit	\$109.00
6364DATB	1963-64, dual adjustable, 27", each	\$59.00
6572DTBK*	1963-72, deluxe, kit	\$109.00
CP32021	1963-72, deluxe (bent bar), kit	\$129.00
6572DATB	1965-72, dual adjustable, 24", each	\$59.00

*Kits will not work with trailing arm reinforcement kit.



MULTI LEAF SPRINGS

Now available are new stock height and drop leaf springs for your car or truck. These are not reconditioned originals, but new leaf springs made to the original factory specs. Sold in pairs. Does not include bushings or U-bolts.

4754FLS-S	1947-54, front, stock height, pair	\$453.00
5559FLS-S	1955-59, front, stock height, pair	\$453.00
4753RLS-S	1947-54, rear, stock height, pair	\$399.00
5455RLS-S	1954-55, rear, stock height, pair	\$395.00
5559RLS-S	1955-59, rear, stock height, pair	\$395.00
CP610-S	1963-72, rear, stock height (1100lbs. rating), pair	\$369.00
CP610-2	1963-72, rear, 2" drop, pair	\$369.00
CP610-3	1963-72, rear, 3" drop, pair	\$369.00
CP610-4	1963-72, rear, 4" drop, pair	\$369.00
CP610-5	1963-72, rear, 5" drop, pair	\$369.00
7172RLS-S	1971-72, rear, stock height (1400lbs. rating), pair	\$395.00

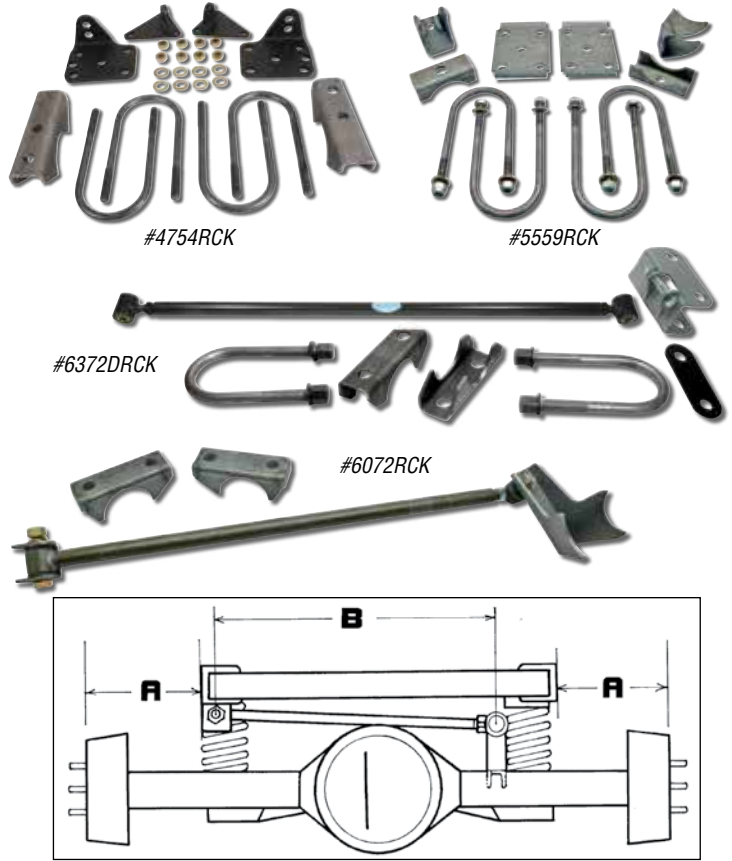

REAR END CONVERSION KIT

Makes rear end swaps a snap! Our kit allows practically any rear end with 3" axle tubes to be installed into your application. Kits include the necessary pieces to upgrade your rear end. Early truck kits can also be used as a flip kit for 4"-5" drop. Welding required!

4754RCK	1947-54, kit (not for factory driveline)	\$139.00
5559RCK	1955-59, kit (not for factory driveline)	\$89.00
6072RCK	1960-72 Basic, kit	\$129.00
6062DRCK	1960-72 Deluxe, kit	\$169.00
6372DRCK	1963-72 Deluxe, kit	\$169.00



REAR LEAF SPRING KITS

When replacing your original rear end with an aftermarket or 9" or 10/12 bolt with a 3" axle tube, these leaf kits are the perfect addition. Teflon buttons and wide leaves allow for a comfortable ride. Kits will yield a 2" drop from stock. Kits include springs, shocks, shackle kit, u-bolts, axle plates and all necessary brackets and hardware to install. New design includes parabolic springs.

432-4610-00	1937-53, kit	\$572.00
432-4610-54	1954-55 (1st Series), kit	\$572.00
433-4610-00	1955-59, kit	\$572.00

FRONT BUMP STOPS

Use our bump stops to keep your suspension from bottoming out.



377	1963-72, Upper - rubber, pair	\$19.00
140	1963-72, Lower - rubber, pair	\$19.00
9-9151G	1963-72, Upper - POLYPLUS, pair	\$8.00
3-9101G	1963-72, Lower - POLYPLUS, pair	\$11.00



REAR BUMP STOPS

Whether you are replacing your rear suspension bushings with factory rubber bushings or upgrading to high performance polyurethane we have the bushings and bump stops for you.

3-9103G	1963-72, Polyurethane, pair	\$10.00
19-1316-BL	1960-72, "Pancake" bump stops	\$12.00

REAR TRAC BAR BUSHINGS

Whether you are replacing your rear suspension bushings with factory rubber bushings or upgrading to high performance polyurethane we have the bushings.



3-7104G	1963-72, POLYPLUS™, pair	\$19.00
3-7116G	1967-72, 3/4 ton Trac Bar Bushings, POLYPLUS™, pair	\$11.00
382	1967-72, 3/4 ton Trac Bar Bushing, rubber, each	\$19.00
851	1963-72, 1/2 ton Trac Bar Bushing, rubber, each	\$16.00

REAR TRAILING ARM BUSHING KITS

CPP offers rear trailing arm bushing kits in both rubber and also in high performance POLYPLUS™, graphite impregnated polyurethane. Kits come with both upper and lower bushings for cars and lower only for trucks. Some POLYPLUS™ bushings require the use of original shells.



3-3123G	1960-72, POLYPLUS™ (req. existing shells), pair	\$16.00
376-K	1960-72, Rubber, pair	\$32.00

REAR TRAC BAR MOUNT



RTAS	1963-72 C10, Rear End Trac Arm Mount Stud, each	\$19.00
TAFMB	1963-72 C10, Trac Bar Frame Mount Bolt & Nut, each	\$3.00

REAR AXLE FLIP KIT

This rear axle flip kit will allow you to lower the rear of your 1973-87 C-10 6". Kit includes: axle locators, axle mounting plates, u-bolts, lock nuts and washers. Note: When using this kit, it must be used with C-notch. See page 43.



7387CNF-K	1973-87, C-10, kit	\$109.00
-----------	--------------------	----------



REAR SHACKLE KITS

Our shackles are designed to be a direct replacement for the factory units. Some of the original hardware will have to be reused on #5559SHK-RE.

4754SHK-R	1947-54 rear, kit	\$125.00
5559SHK-R	1955-59 rear, kit	\$115.00
5559SHK-RE	1955-59 - 2" extended, kit	\$49.00
6372SHK-R	1963-72 - stock height, each	\$59.00
6372SHK-RE	1963-72 - drop, extended, pair	\$69.00
7387SHK-RE	1973-87 - drop, extended, pair	\$49.00

LEAF SPRING CONVERSION KIT

Used to center the rear axle in the fender opening when installing a late model rear axle with stock leaf springs. Moves rear axle 1-1/2".



4753LSC-K	1947-53, pair	\$29.00
-----------	---------------	---------



WELD-ON REAR AXLE SEATS

When you lower your vehicle or convert to a later year axle these are a must. 1947-54 fits with original leaf springs when upgrading to later style rear axle. Note: Works with 3" axle tubes.

4754RAS	1947-54, 1-3/4" wide, pair	\$19.00
5559RAS	1955-59, 2" wide, pair	\$19.00
6072RAS	1960-72, pair	\$39.00

TUBULAR REPLACEMENT REAR SHOCK CROSSMEMBER

Heavy gauge steel replacement fits 1955-59 Chevy trucks. May require a shock change.



5359RSX	1955-59, each	\$119.00
---------	---------------	----------



LEAF SPRING BUSHING KITS

CPP offers leaf spring bushing kits in both rubber and also in high performance Polyplus™, graphite impregnated polyurethane. Kits are available for fixed end, shackle and complete sets. Fixed end kits may have a solid bushing or 2 part bushing depending on the application. #SK8154-K also includes bolts.

3-2106G	1973-87, Complete POLYPLUS™, (1-1/2" frame shackle), kit	\$69.00
3-2108G	1981-87, Complete POLYPLUS™, (1-3/8" frame shackle), kit	\$69.00



CURRIE CRATE REAR ENDS

These feature the 9-Plus heavy duty housing and 31 spline "Currie Axle" and are built to the stock overall width and pinion offset specifications. Housings have all the original bracketry to remove your original rear end and bolt this new 9" housing directly in. Housings include 3rd member studs installed and Torino-style late model large bearing housing ends. GM replacements come with 6x5.5 bolt circle and 7/16" wheel studs and 5x5 bolt circle and 1/2" wheel studs. This housing requires the use of a deluxe (trailing arm mounted) trac bar, which is included. Third members and brake kits sold separate. *Note: Kits will not work for leaf spring trucks.*



GMT6370X5	1963-70 5 lug, kit	\$1,239.00
GMT6370X6	1963-70 6 lug, kit	\$1,239.00
GMT7087X5	1970-87 5 lug, kit (trailing arms)	\$1,239.00
GMT7087X6	1970-87 6 lug, kit (trailing arms)	\$1,239.00

THIRD MEMBERS



These Currie Third Members are designed to fit Ford 9" applications with 31 spline axles and are all new parts. Available with open differential or traction lock. Specify gear ratio when ordering. 3.00-5.14 ratios available. *Note: An additional \$39 fee for protective case when shipping from manufacturer or CPP. No additional charge for Will Call pick up.*



90D	Open Differential	\$1,499.00
9TL	Traction Lock	\$1,799.00
9IK-OD	Fluid, kit (open differential)	\$21.00
9IK-TL	Fluid, kit (traction lock)	\$28.00

5-LUG REAR AXLE CONVERSION KITS

If you've upgraded your 6 lug truck to 5x5 in front, this is the kit to convert the rear. Complete kit come with axles and drums. 1963-64 kit also include spider gears. 1/2" studs. *Note: 1/2 ton only, not for Dana rear end.*



6364RACK*	1963-64 Complete kit, (30.75" axle), kit (includes #C12TOSS)	\$499.00
6569RACK	1965-69 Complete kit, (30.75" axle), kit	\$329.00
70RACK	1970 Complete kit, (31.5" axle), kit	\$329.00
6369RAC-5	1963-69 Axles, pair	\$289.00
70RAC-5	1970 Axles, pair	\$289.00
CP8602	1971-72 5-lug brake drum, pair	\$69.00

* Will not work with 17 spline posi unit.

OPEN SPIDER 5 LUG AXLE CONVERSION



A must when doing axle conversion. Used with 1965-69 axles (#6569RAS).

C12TOSS	1963-64, kit	\$175.00
----------------	--------------	-----------------



SLIP SHAFT DRIVELINE

The ultimate in drivelines is now available from Classic Performance Products. Slip shaft drivelines with aluminum housing, are self adjusting - 33.75" collapsed to 36.5" expanded, which minimizes wear and tear on the carrier bearing and rear-end on vehicles where the ride height has been altered. We also carry OEM rubber carrier bearings and heavy duty polyurethane carrier bearings. *Note: works with 2 piece driveline truck.*

CPSSD	1963-72, Slip Shaft Driveline, each	\$199.00
CPRCB	1963-72, Stock Rubber Carrier Bearing, each	\$29.00
CPPCB	1963-72, Polyurethane Carrier Bearing, each	\$109.00

CARRIER BEARING CONVERSION KIT

Support your truck's driveshaft with our center carrier bearing conversion kit. Bracket and hardware included. For use with 2-piece driveshaft.



CSBC	1963-72, Bearing and Bracket, kit	\$84.00
CBC	1963-72, Bearing only, kit	\$35.00
CBB	1963-72, Bracket only, kit	\$49.00

TRAILING ARM REINFORCEMENT KIT

Includes two pairs of laser cut upper and lower reinforcement plates, POLYPLUS bushings, U-bolts and mounting hardware. Upgrade and rebuild at the same time. Gives you a much stronger rear suspension for your truck. *Note: Will not work with deluxe trac bar.*



6072TAR-K	1960-72, kit	\$99.00
------------------	--------------	----------------

REAR PINION ANGLE SHIMS

For lowered truck applications with rear coil springs. These shims correct drive shaft mis-alignment that can cause driveline vibrations and excessive carrier bearing wear.



6072RPS-1	1960-72, 1°, pair	\$47.00
6072RPS-2	1960-72, 2°, pair	\$65.00
6072RPS-3	1960-72, 3°, pair	\$69.00
6072RPS-4	1960-72, 4°, pair	\$69.00

FRAME STIFFENERS

Our frame stiffeners add extra reinforcement to your sagging or corroded frame rails. 17" sections. Sold in pairs. Heavy gauge steel. Trim or drill as needed.



6372RFS	1963-72, pair	\$39.00
----------------	---------------	----------------



ENGINE AND TRANSMISSION MOUNTS

CPP has everything from trim to fit universal engine mounts and transmission crossmembers to specific applications for your classic Chevy truck. We've also got you covered for those LS motor conversions with our plates and conversion kits. Engine crossmembers are not recommended for vehicles with IFS. GM small block engine crossmembers are designed to fit vehicles with an inside distance between the frame rails of 24"-37".

CP4810*	1947-59, engine crossmember, small/big block, each	\$59.00
CP4810-S*	1940-59, Weld-in side mounts with IFS, small/big block, pair	\$79.00
6372MP-SM	1963-72, small block, engine pedestals, pair	\$159.00
6372MP-BM	1963-72, big block, engine pedestals, pair	\$169.00
CP9424	1947-59, transmission crossmember, each	\$59.00
CP9427	1963-72, transmission crossmember, each	\$79.00
CP90171	1973-87, transmission crossmember, each	\$79.00

* These may fit other applications as well.



#CP4810-LS1RK



#CP4810-LS1PK

LS ENGINE CONVERSION KIT FOR STRAIGHT AXLE

Updating your early hauler to a modern drive train could not be any easier than our straight axle LS Series engine and LS adapter brackets. The crossmember can be bolted to the frame and the FiteRite™ LS adapters will make installation quick and easy.

CP4810-LS1PK	Poly bushings, kit	\$179.00
CP4810-LS1RK	Rubber bushings, kit	\$159.00



FITRITE™ LS SWAP ENGINE PLATES WITH POLYPLUS™ PAD MOUNTS

Our exclusive design no-weld brackets are CNC laser cut steel and features a durable black powder coat finish. These exclusive bracket kits are available in two different configurations. The long adapter kit (#LS1-KU-P) allows the engine to move from 1/2" rearward (great for oil pan to crossmember clearance) up to 3" forward for a full 3-1/2" of travel with a completely custom range of positions. The short adapter kit (#LS1-KULAC-P) is a smaller, more compact version, moving the engine from 2-1/4" forward to 3-3/4" forward for a total of 1-1/2" of travel. The advanced materials used in the POLYPLUS™ pad mounts allow them to withstand the abusive elements that your vehicle encounters on a daily basis.

LS1-KU-P	Long kit - adjustable 1/2" rear - 3-1/2" forward	\$129.00
LS1-KULAC-P	Short kit - adj. 2-1/4" - 3-3/4" forward for low A/C compressor	\$129.00



ENGINE PADS

55590FM	1955-59, OE V8 engine, kit	\$135.00
7-509-BL	1963-72, OE, pair (not for CPP pedestals)	\$90.00

SEE OUR PARK SAFETY SWITCH INSTALLATION & ADJUSTMENT INSTRUCTIONS IN THE TECH SECTION - PAGE 353



#TC-6772-FC



#TC-6772-SB



CPP CLASSIC FIT™ TILT STEERING COLUMN

5-way adjusting tilt columns for those who want great performance at affordable pricing. Made from steel 2" tube for automatic column shift and all floor shift applications and available in chrome and black finish. Columns come with 3/4"-36 output shafts. All columns accepts any 1967-94 GM steering wheel or aftermarket adapter. Column shift columns come with both 3-speed and 4-speed shift indicators. 1967-72 truck columns feature factory style floor seal, retaining ring dash seal and knobs.

TC-6772-SB	1967-72, black, with shift	\$325.00
TC-6772-FB	1967-72, black, without shift	\$325.00
TC-6772-SC	1967-72, chrome, with shift	\$399.00
TC-6772-FC	1967-72, chrome, without shift	\$399.00



IDIDIT STEEL TILT STEERING COLUMNS



The ididit, inc. company has been manufacturing quality steering columns made in the USA for 25 years! These columns are all 100% brand new and come with turn signal and 4 way flashers. Retrofit columns for vehicles 1967 and later will adapt to factory wiring. Earlier models and Street Rod columns will require adapter kits or custom wiring. Available in plain steel and chrome and come standard with 3-7/8" GM wiring and accept GM wheels or aftermarket wheels. Many custom options are available like: black powder coating, brushed or polished aluminum, keyed and keyless ignition, dimmer and cruise control, please inquire.

Retrofit Column Shift:

1130651010	1947-54 Plain Steel (1"DD Spline), each	\$708.00
1130651020	1947-54 Chrome (1"DD Spline), each	\$892.00
1140652010	1955-59 Plain Steel (1"DD Spline), each	\$735.00
1140652020	1955-59 Chrome (1"DD Spline), each	\$919.00
1140650010	1960-66 Plain Steel (3/4"-36 Spline), each	\$720.00
1140650020	1960-66 Chrome (3/4"-36 Spline), each	\$904.00
1140657010	1967-72 Plain Steel (3/4"-36 Spline), each	\$674.00
1140657020	1967-72 Chrome (3/4"-36 Spline), each	\$858.00
1540760010	1973-78 w/key Plain Steel (1"-48 Spline), each	\$1,022.00
1540760020	1973-78 Chrome w/ key (1"-48 Spline), each	\$1,206.00

Retrofit Floor Shift:

1120651010	1947-54 Plain Steel (1"DD Spline), each	\$484.00
1120651020	1947-54 Chrome (1"DD Spline), each	\$621.00
1120652010	1955-59 Plain Steel (1"DD Spline), each	\$525.00
1120652020	1955-59 Chrome (1"DD Spline), each	\$648.00
1120650010	1960-66 Plain Steel (3/4"-36 Spline), each	\$462.00
1120650020	1960-66 Chrome (3/4"-36 Spline), each	\$586.00
1120657010	1967-72 Plain Steel (3/4"-36 Spline), each	\$417.00
1120657020	1967-72 Chrome (3/4"-36 Spline), each	\$540.00
1520760010	1973-78 w/key Plain Steel (1"-48 Spline), each	\$757.00
1520760020	1973-78 Chrome w/ key (1"-48 Spline), each	\$879.00



COLUMN SHIFT INDICATOR KITS

Kit includes appropriate housing, indicator lens, and pointer. An often overlooked item in a restoration. *Note: Fits OEM type columns only.*

63660SCI-C	1962-66, chrome, kit	\$19.00
71720SCI	1969-72 - no tilt, kit	\$25.00
71720SCI-TC	1971-72 - w/ tilt - chrome, kit	\$25.00
71720SCI-T	1971-72 - w/ tilt, kit	\$20.00
71720SCI-TOD	1971-72 - w/ tilt & 4 speed trans, kit	\$20.00

WIRE HARNESS FOR STEERING COLUMN

Required to connect CPP Classic Fit™ columns to original wiring.



6772WHP	1967-72, each	\$19.00
----------------	---------------	----------------

FLOOR MOUNT PLATE

When installing a CPP Classic Fit™ or Ididit steering column in your 1955-59 Chevy truck, it is necessary to replace the original floor plate with this new plate that will accommodate a 2" diameter steering column.



CFM-C-200	1955-59 Tilt Column Floor Mount Plate - 2", each	\$19.00
CFM-C-225	1955-59 Tilt Column Floor Mount Plate - 2-1/4", each	\$19.00

DELUXE COLUMN FLOOR MOUNT

Our floor mount bolts to the floor board and covers the hole left from the original column. This piece should be welded to the column.



IDIFMD	Deluxe Column Floor Mount w/ Vinyl Boot & Billet Trim Ring (specify column diameter), each	\$63.00
---------------	--	----------------

CHEVROLET TRUCK



#4759PSK-S500



#CPP6366PSK-S



#CPP5559PSK-OC

POWER STEERING CONVERSION KITS

CPP has the newest technology power steering conversion kits for your classic! We've got you covered with our 400 Series™ for your vintage truck, 500 Series™ for your classic Chevy and now offer late model performance steering for your classic Ford car or Chevy Corvette. All kits include power steering box ready to bolt to your frame. Kit contents may vary. *Note: For #CPP4759PSK-S please specify stock or lowered height. Also, #CPP5559PSK-OC, may, in rare occasions, require the use of custom drag link kit.*

4759PSK-S500	1947-59, with CPP 500 Series™ box, kit	\$749.00
CPP5559PSK-AC	1955-59, with CPP 400 Series™ box, for 1"DD aftermarket column, kit	\$549.00
CPP5559PSK-OC	1955-59, with CPP 400 Series™ box, for stock column, kit	\$539.00
CPP6062PSK-S	1960-62, with CPP 500 Series™ box, kit	\$749.00
CPP6366PSK-S	1963-66, with CPP 500 Series™ box, kit	\$749.00
CPP6772PSK-S	1967-72, with CPP 500 Series™ box, kit	\$699.00
5559DL-K400	1955-59, Custom Drag Link	\$59.00



#4759PSK



#6366PSK

BASIC POWER STEERING KIT

These conversion kits have the basic pieces needed to add power steering to your stock suspension Classic Chevy truck. Kits will allow the use of a 1969-87 Chevy 2WD pickup power steering box or CPP #CP50014 500 Series™ Power Steering Box. #4759PSK also requires the use of a 4" custom pitman arm available on page 38.

4759PSK	1947-59, kit	\$119.00
6062PSK	1960-62, kit	\$95.00
6366PSK	1963-66, kit	\$95.00

ALTERNATOR BRACKETS

These brackets are designed to allow for additional clearance for items like tall valve covers, power steering and certain carb set ups.



37-1250	1937-55 Chevy Truck, 1st series 6 cyl conv. bracket, kit	\$75.00
55-1250	1955-62 Chevy Truck, 6 cyl conv. bracket, kit	\$75.00



EARLY CHEVY TRUCK POWER STEERING KIT

This new kit allows you to install a 1969-87 Chevy 2WD power steering box or CPP #CP50014 500 Series™ Power Steering Box onto your 1947-59 Chevy Truck. Includes power steering conversion kit, pitman arm and collapsible intermediate shaft. CPP's new intermediate shaft is much safer than a solid shaft and includes 13/16"-36 steering box U-joints. Column U-joint sold separately.

4759BSK	1947-59, kit	\$299.00
----------------	--------------	-----------------



INTERMEDIATE STEERING SHAFT

Whether installing late model power steering on your straight axle or adding an independent front suspension, this collapsible intermediate shaft is much safer than a solid shaft. Sold with or without U-joints. *Please specify column and gearbox spline.

4759ISS	1947-59, without U-joints, each	\$45.00
4759CSS*	1947-59, with U-joints, each	\$139.00

See page 283 in Universal Section for U-Joints



#CP50014

500 Series™



NEW
New billet aluminum cap coming soon!

See page 38 for Pitman Arms

#920023



#CP7501V



#CP50006C

400 Series™

STEERING BOXES

CPP carries a host of power steering boxes. These boxes bolt directly to your frame without any need for additional brackets or adapters. CPP 400 Series™ are a compact design power steering box that is an easy bolt on alternative to rack & pinion systems or the traditional Toyota box conversion for classic trucks. Original replacement power steering boxes are available in standard and quick ratios. Both 400 Series™ and 500 Series™ use 3/4"-30 coupler. OE power boxes use 13/16"-36 coupler. All power boxes use inverted flare hoses.

CP50006C	1955-59, 400 Series™, NEW, each	\$379.00
CP7501C	1969-76, 2WD truck, 16:1 ratio, rebuilt, each	\$275.00
CP7501V	1969-76, 2WD truck, 14:1 ratio, rebuilt, each	\$275.00
CP50014	1969-90, 500 Series™, 2WD truck, NEW, each	\$379.00
920023	1968-78 C10, manual gear box, each	\$309.00



#6872PSPBK-BB

OE-STYLE BIG BLOCK POWER STEERING PUMP & BRACKETS

Original fit and finish! Kit includes NEW pump with housing, remote canister with cap, lower pump cradle bracket, upper pump adjuster bracket and mounting hardware.



#6572PSBK-BB

6872PSPBK-BB	1968-72 C-10 with BBC, complete kit	\$289.00
6572PSBK-BB	1968-72 C-10 with BBC, pump cradle & adjuster, kit	\$69.00



#19-6168SB-6

#19-6168SB-6C

#19-6372BB

#6872PSR-C

#72PSR-H*



*All reservoir kits include O-rings and fittings!



*All pump kits include NEW 19- pump installed!



#6872PSH-KBB*

POWER STEERING PUMP AND RESERVOIR KITS

These 100% brand new pumps and reservoirs have a beautiful OEM appearance and function. Reservoirs come with all o-rings and fittings, including an AN adapter, if necessary to install in your application. All pump kits include **brand new** #19-PUMP installed. When appearance is a concern, use these OE style pumps and reservoirs.

COMPLETE PUMP KITS:

19-6168SB-6P	1963-72 6 cyl and small block, plain, each	\$159.00
19-6168SB-6PC	1963-72 6 cyl and small block, chrome, each	\$169.00
19-6372BB-P	1968-72 big block, each	\$179.00
6872PSP-KBB	1968-72 big block with canister, kit	\$229.00

RESERVOIR ONLY KITS:

19-6168SB-6	1963-72 6 cyl and small block, plain, each	\$39.00
19-6168SB-6C	1963-72 6 cyl and small block, chrome, each	\$49.00
19-6372BB	1968-72 big block, each	\$69.00
6872PSH-KBB	1968-72 big block with canister, kit	\$129.00
72PSR-H	1968-72 big block Canister, each	\$59.00
6872PSR-C	1968-72 big block Canister Cap, each	\$15.00



#5559PSK-A

POWER ASSIST STEERING KIT

This system is great for the purist. It bolts to the existing steering system and clears all of the factory components. This will allow the use of factory steering columns and allow for a stock look without having to suffer with manual steering. Kit includes power cylinder, drag link, heavy duty tie rod, new style tie rod ends, rebuilt control valve assembly, hoses and all necessary mounting hardware. Power steering pump not included. *Note: Will require modification to the original pitman arm. Modified pitman arms available for \$89 exchange or \$239 outright. Note: Wheels wider than stock may rub control valve and 6 cylinders may require fabricating power steering pump brackets.*

4752PSK-A	1947-52, kit	Inquire
5354PSK-A	1953-54, kit	Inquire
5559PSK-A	1955-59, kit	Inquire



#4753AGT-BS

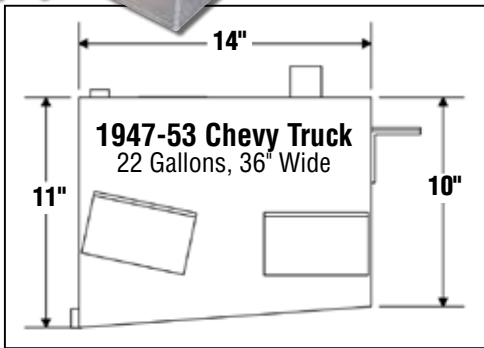

#5455AGT-BS

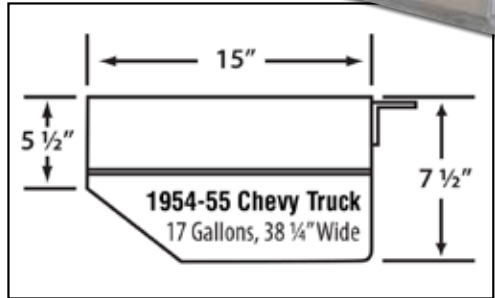

OS
Gas Tanks ship O/S
additional freight
charges apply.

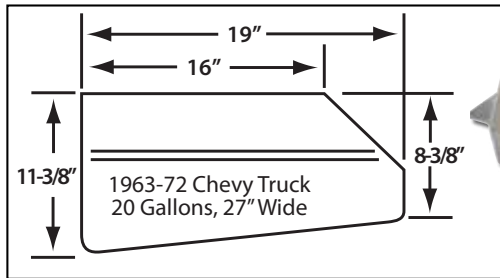

#6372AGT-20BS

ALUMINUM GAS TANKS OS

Tanks fit between the frame rails, are fully baffled and compatible with EFI or carbureted applications. Suburban tanks are designed to fill in the original location and all other tanks are available in a bed fill standard (-BS), which is accessible through a fuel fill door, in a bed fill flush (-BF), which is accessible through a flush mount cap and in a side fill (-S). These tanks are made from .125" 5051 aluminum and have a .187" mounting bracket. It's the thickest and strongest in the industry! #5559AGT is notched for leaf spring clearance and will NOT work on 1958-59 Fleetsides. **Sending units sold separately.** Custom tanks available, please inquire. *Note: Gas tanks ship O/S; additional freight charges apply. Also, 1947-54 tanks will not work on 3/4 ton. Fuel Injected tanks include in tank pumps. See chart at right to choose the right tank.*

CHOOSING THE RIGHT TANK

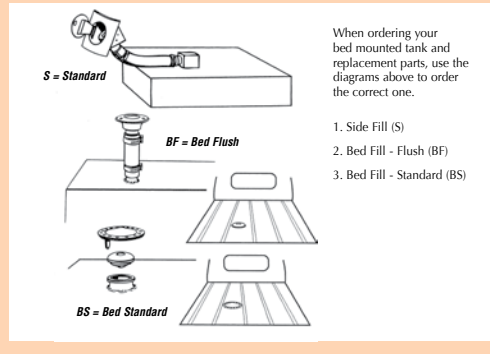

CARBURATED: *Note: Will not work on 1958-59 Fleetside

4753AGT-S	1947-53, Side Fill (req. C-notch in frame), 22 gallon, each	\$479.00
4753AGT-BF	1947-53, Bed Fill - flush, 22 gallon, each	\$479.00
4753AGT-BS	1947-53, Bed Fill - standard, 22 gallon, each	\$479.00
5455AGT-S	1954-55, Side Fill (req. C-notch in frame), 17 gallon, each	\$479.00
5455AGT-BF	1954-55, Bed Fill - flush, 17 gallon, each	\$479.00
5455AGT-BS	1954-55, Bed Fill - standard, 17 gallon, each	\$479.00
5559AGT-20S*	1955-59, Side Fill, 20 gallon, each	\$479.00
5559AGT-20BF*	1955-59, Bed Fill - flush, 20 gallon, each	\$479.00
5559AGT-20BS*	1955-59, Bed Fill - standard, 20 gallon, each	\$479.00
6372AGT-SB	1963-72 Suburban, 26 gallon, kit	\$509.00
6372AGT-20BF	1963-72, Bed Fill - flush, 20 gallon, each	\$479.00
6372AGT-20BS	1963-72, Bed Fill - standard, 20 gallon, each	\$479.00
6372AGT-20S	1963-72, Side Fill (req. C-notch in frame), 20 gallon, each	\$479.00
7387AGT-22S	1973-87, Side Fill (req. C-notch in frame), 22 gallon, each	\$479.00
7387AGT-22BF	1973-87, Bed Fill - flush, 22 gallon, each	\$479.00
7387AGT-22BS	1973-87, Bed Fill - standard, 22 gallon, each	\$479.00

CHEVROLET TRUCK

TANK INSTALL KITS AVAILABLE!



\$119⁰⁰

#AGT-BFIK30 (0-30 OHM) and #AGT-BFIK90 (0-90 OHM)
plus other accessories and separate components available on next page



#6372AGT-SB



#5559AGT-20BS

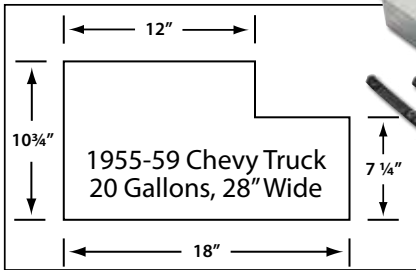
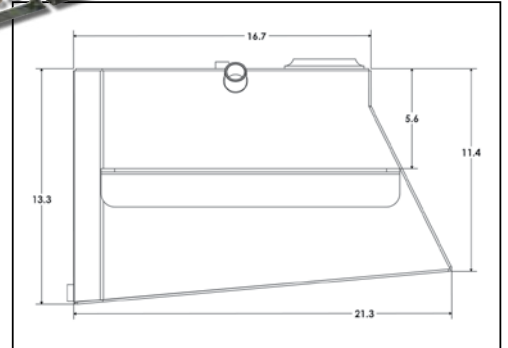

Gas Tanks ship O/S
additional freight
charges apply.

#7387AGT-22BF

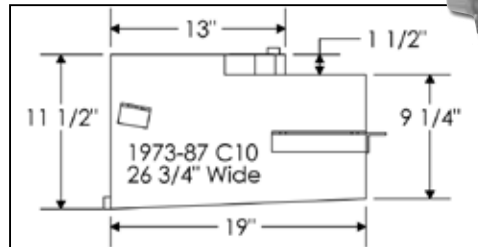

Fuel Pump Kit for Original-Style Fuel Injected Tanks

- 255 Liters per hour - up to 600hp
- 109 Liters per hour for TBI
- 400 Liters per hour - 500-1000hp high performance

Starting at \$190⁰⁰/ea

FUEL INJECTED
TANKS NOW AVAILABLE!
INCLUDES IN TANK
FUEL PUMP

WANT TO USE A CPP TANK WITH YOUR
FUEL INJECTED MOTOR?
GET OUR UNIVERSAL FUEL PUMP!

#UFPK-FI (Shown installed) - \$235.00

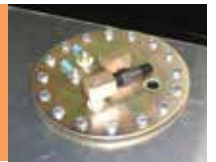

FUEL INJECTED: *Note: Will not work on 1958-59 Fleetside (fuel injected tanks include in tank fuel pump)

4753AGT-S-FI	1947-53, Side Fill (req. C-notch in frame), 22 gallon, each	\$769.00
4753AGT-BF-FI	1947-53, Bed Fill - flush, 22 gallon, each	\$769.00
4753AGT-BS-FI	1947-53, Bed Fill - standard, 22 gallon, each	\$769.00
5455AGT-S-FI	1954-55, Side Fill (req. C-notch in frame), 17 gallon, each	\$769.00
5455AGT-BF-FI	1954-55, Bed Fill - flush, 17 gallon, each	\$769.00
5455AGT-BS-FI	1954-55, Bed Fill - standard, 17 gallon, each	\$769.00
5559AGT-20S-FI*	1955-59, Side Fill, 20 gallon, each	\$769.00
5559AGT-20BF-FI*	1955-59, Bed Fill - flush, 20 gallon, each	\$769.00
5559AGT-20BS-FI*	1955-59, Bed Fill - standard, 20 gallon, each	\$769.00
6372AGT-SB-FI	1963-72 Suburban, 26 gallon, kit	\$799.00
6372AGT-20BF-FI	1963-72, Bed Fill - flush, 20 gallon, each	\$769.00
6372AGT-20BS-FI	1963-72, Bed Fill - standard, 20 gallon, each	\$769.00
6372AGT-20S-FI	1963-72, Side Fill (req. C-notch in frame), 20 gallon, each	\$769.00
7387AGT-22S-FI	1973-87, Side Fill (req. C-notch in frame), 22 gallon, each	\$769.00
7387AGT-22BF-FI	1973-87, Bed Fill - flush, 22 gallon, each	\$769.00
7387AGT-22BS-FI	1973-87, Bed Fill - standard, 22 gallon, each	\$769.00

#SS5559C



#SS632C



STAINLESS STEEL GAS TANKS

These tanks are hand formed from 304 grade stainless and TIG welded. All tanks feature unique baffle system that will control fuel tank slosh. Each tank has baffles running front to rear, side to side and surrounding the fuel tank pickups to eliminate fuel starvation during acceleration and hard braking. All tanks include stainless steel mounting strap and/or hardware. Tanks have a brushed finish and accept aftermarket sending units (sold separately). Carbureted tanks have a 3/8" NPT fuel supply. Fuel injection tanks include fuel pump, installed, that supports up to 405HP. Fuel pumps sits in a separate chamber within the tank to eliminate starvation during low tank levels. Fuel injection tanks feature a -6AN supply and return. *Note: Gas tanks ship O/S; additional freight charges apply. Any interruption in fuel flow will cause an injected motor to stall. With Rick's Hot Rod Shop fuel pump chamber this will eliminate any interruption in flow.*

SS474C	1947-54, flush fill w/ carburetor, 18 gallon	\$748.00
SS474FI	1947-54, fuel injection, 18 gallon	\$1,162.00
SS559C	1955-59, flush fill w/ carburetor, 18 gallon	\$748.00
SS559FI	1955-59, fuel injection, 18 gallon	\$1,162.00
SS632C	1963-72, flush fill w/ carburetor, 18 gallon	\$748.00
SS632FI	1963-72, fuel injection, 18 gallon	\$1,162.00

LS FUEL FILTER REGULATOR KIT

These fuel regulator/filter combinations are a must with any LS engine conversion. Available in standard barb or -6AN Quick disconnect fittings. Perfect for plumbing your own fuel system.



LS9904	LS fuel filter/regulator 58 psi, each	\$35.00
LS9904-KIT	LS fuel filter/regulator 58 psi, with -6 AN quick disconnect fittings, kit	\$70.00



LS FUEL LINE KIT

Purchasing a LS style gas tank conversion? We now have a complete fuel line and regulator kit to plumb all your fuel lines in your ride. Comes with fuel hose, all fittings (standard or 45° ends), and regulator/filter combo.

LS-LINE-KIT	Fuel line kit for LS engine	\$235.00
LS-LINE-KIT45	Fuel line kit for LS engine with 2- 45 degree hose ends	\$247.00



#UFPK-FI



#FPK-FI

FUEL PUMP KITS FOR ORIGINAL-STYLE FUEL INJECTED TANKS

These high quality 8 amp/12 volt electric fuel pumps are quiet, reliable, and a must for your fuel injected engine. Kits include cushioned mounting brackets, fittings, clamps, and hardware.

UFPK-FI	Universal In-Tank Pump, kit	\$235.00
FPK-FI	255 Liters per hour - up to 600hp	\$220.00
LV-FPK-FI	109 Liters per hour for TBI	\$190.00
HV-FPK-FI	400 Liters per hour - 500-1000hp high performance	\$280.00

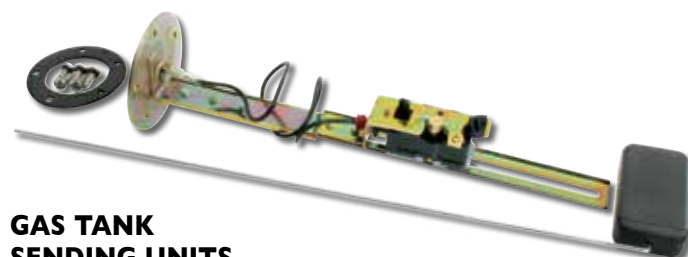

GAS TANK SENDING UNITS

For use with our aluminum, stainless, and zinc painted bed mounted relocation gas tanks.

VSU-3	0-30 ohm, each	\$49.00
VSU-9	0-90 ohm, each	\$49.00
VSU-F	73-10 ohm, each	\$49.00
VSU-240	240-330 ohm, each	\$69.00



#5455SGT-BF



#6372SGT-BF



#5559SGT-BF

STEEL ZINC PAINTED GAS TANKS

These frame mounted, bed fill gas tanks are manufactured with quality steel and zinc painted. Perfect for underbed conversions. Mounts to frame rails behind the rear axle, allowing you to remove the original in-cab tank. *Note: Only available in bed flush. Will not work with 3/4 ton frame.*

4753SGT-BF	1947-53 Chevrolet/GMC truck, each	\$379.00
5455SGT-BF	1954-55 1st Series Chevrolet/GMC truck, each	\$379.00
5559SGT-BF	1955-59 Chevrolet/GMC truck, each	\$379.00
6372SGT-BF	1963-72 Chevrolet/GMC truck, each	\$379.00



#6366FMT-K

OEM STYLE GAS TANKS

OEM gas tanks available for your classic car or truck. Tanks are the factory dimensions and have the factory capacity. #6366FMT-K and #6772FMT-K are designed to convert from cab to under the bed. In some applications it may be necessary to notch rear bed cross sill 1/8"-1/4" to provide clearance for this tank. *Note: Also, gas tanks ship O/S; additional freight charges apply.*

6366FMT-K	1963-66 complete kit (21 gallon), Blazer Tank Conversion	\$249.00
6772FMT-K	1967-72 complete kit (21 gallon), Blazer Tank Conversion	\$249.00
6772FMT	1967-72 Blazer and Suburban, (21 gallon), tank only	\$199.00

CHOOSING THE RIGHT TANK

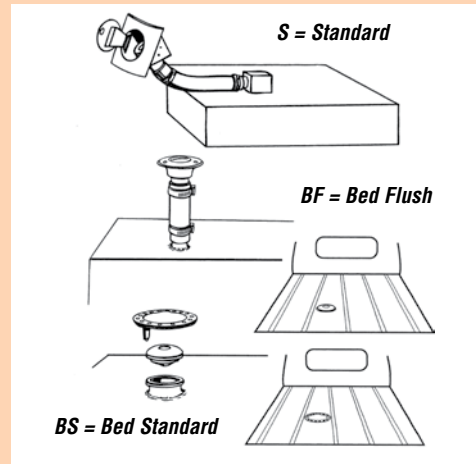

When ordering your bed mounted tank and replacement parts, use the diagrams above to order the correct one.

1. Side Fill (S)
2. Bed Fill - Flush (BF)
3. Bed Fill - Standard (BS)



Gas Tanks ship O/S
additional freight
charges apply.



CHROME GAS CAP FOR STEPSIDE, FLEETSIDE OR BLAZER

Over time the gas cap seals can crack with age and leak fuel. This will ruin your paint job. Protect your investment with a new vented OEM style replacement gas cap, similar to the original. *NOTE: Fits 1971-78 Fleetsides and 1973-78 Stepsides.*



7178GCNL	1971-78, non-locking, each	\$5.00
LGC	1947-71, locking, each	\$10.00

STOCK GAS TANK FILLERS

For use with your original or reproduction OEM-style cab mounted gas tank. Kit includes painted or chrome plated fill tube, seal, cap, clamps and hoses.

47540GF-K	1947-54, painted, kit	\$59.00
47540GF-KC	1947-54, chrome, kit	\$129.00
55590GF-K	1955-59, painted, kit	\$59.00
55590GF-KC	1955-59, chrome, kit	\$129.00

GAS TANK FILLER NECK GROMMET

With time, gas tank filler neck grommets shrink and crack. Replace yours today, especially if you're going to repaint your vehicle.



4954GTFNG	1949-54, each	\$4.00
5559GTFNG	1955-59, each	\$4.00
6770GTFNG	1967-70, each	\$5.00
7172GTFNG	1971-72 each	\$5.00

GAS TANK MOUNTING PADS

These thick tar paper pads fit between the gas tank and the cab to provide a protective metal-to-metal barrier, which increases safety and minimizes rattle and other noise.



4972GTMP	1949-72, each	\$4.00
----------	---------------	--------

GAS TANK FLOOR SEAL

Seals between bottom of gas tank and hole in floor.



4959GTFSD	1949-59, each	\$2.00
-----------	---------------	--------

STOCK GAS TANK SENDER FLOAT

If you have a faulty float you will get an inaccurate gas gauge reading or none at all.



4772GTSF	1947-72, each	\$9.00
----------	---------------	--------

GAS TANK SENDING UNIT GASKET

You don't want gas leaking from your gas tank; it's dangerous! Replacing your aged gas tank sending unit gasket will help ensure this doesn't happen.



4766GTSUG	1947-66, each	\$2.00
-----------	---------------	--------

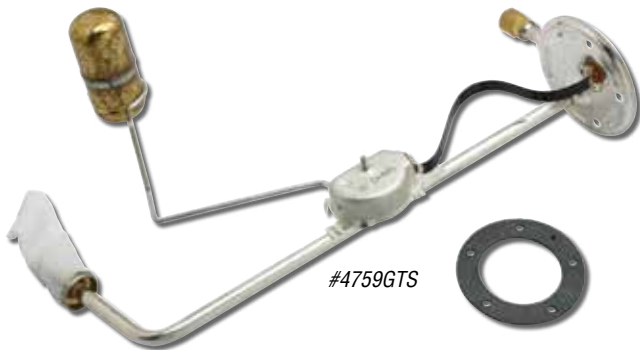

STOCK TYPE GAS TANK SENDING UNIT

Does your gas gauge stick or give inaccurate readings? Resolve the problem by replacing your aged gas tank sending unit with our OEM quality unit. This complete assembly installs inside the gas tank. Fits factory tanks with stock gauges.

4753GTS	1947-53, sending unit, each	\$39.00
6366GSU	1963-66, sending unit (Blazer tank conversion), each	\$45.00
6772GSU	1967-72, sending unit (Blazer tank conversion), each	\$45.00



GAS TANK STRAP

These galvanized steel straps, which include hardware, will hold your tank securely in place and maintain an OEM look.

6372GTS	1963-72, each	\$30.00
---------	---------------	---------

FIBERGLASS WHEEL TUBS

These fiberglass front wheel tubs are designed for extremely lowered trucks, like those using Porterbuilt dropmembers or other air ride suspensions. Not only do they bolt in like the factory inner fenders do, but they also cover the wider and bigger wheel and tire combo that some like to run; while keeping water and trash out of the engine compartment. They are still open enough to showcase custom front suspensions.



6772LWT	1967-72 C-10, pair	\$650.00
7380LWT	1973-86 C-10, pair	\$635.00
8187LWT	1981-87 C-10, pair	\$635.00



#4753CG



#5556CG

CHROME REPRODUCTION GRILLES

Brighten up your truck with one of our reproduction chrome grilles. Our grilles come with a brilliant chrome finish and are fully assembled for an easy installation. Grill kits include shell, inner grill, headlight bezels and install kit.

4753CG	1947-53, each	\$499.00
4754CG-GMC	1947-54 GMC, each	\$529.00
5455CG	1954-55 1st Series, each	\$839.00
5556CG	1955-56, each	\$329.00
57CG	1957, each	\$699.00
5859CG	1958-59, each	\$299.00
6466CG	1964-66, (includes headline bezels) each	\$299.00
6970CG	1969-70, (with decal Chevrolet) kit	\$419.00
7172CG	1971-72, kit	\$449.00



ROLL PANS

Give your truck the smooth sano look with one of our steel roll pans. Our roll pans feature all steel construction and can be welded in or bolted in. Available styles include smooth with no license plate box and smooth with license plate box.

4754RP-S	1947-53 Stepside Smooth, each	\$100.00
4754RPL-S	1947-53 Stepside w/ License Plate Box, each	\$139.00
5559RP-S	1955-59 Plain Stepside Roll Pan, each	\$100.00
5559RPL-S	1955-59 Stepside Roll Pan w/ License Plate Cutout, each	\$139.00
5859RP-F	1958-59 Plain Fleetside Roll Pan, each	\$139.00
5859RPL-F	1958-59 Fleetside Roll Pan w/ License Plate Cutout, each	\$139.00



CHROME BUMPERS

Freshen up your truck with a new chrome bumper. Our bumpers are exact reproductions of the originals and feature a high luster chrome finish. Rear bumper brackets and bolts sold separately.

4754CFB	1947-54 Front Bumper, each	\$190.00
4753CRB	1947-53 Rear Bumper, each	\$190.00
4754RBB	1947-54 Rear Bumper Bracket, set	\$95.00
CRB	Chrome Bumper Bolts, each	\$3.00



HEADERS

All Doug Thorley Header models are constructed of 14-gauge steel for ultimate longevity. Custom designs and tunes are engineered to perform and fit flawlessly under your hood. Coated inside and out with a Ceramic-Thermal Coating that protects your header from the elements and withstands up to 1,400 degrees F, these Doug Thorley headers promote exhaust velocity and absorb up to 40% of the engine temperature to keep your engine cooler and running more efficiently. These LS Series motor swap line up are available in a big tube 1 7/8" headers for the and also available in 1 5/8" primaries.

THY-322Y-C	1963-66 C10 with LS, 1-7/8" primary tube, pair	\$677.00
THY-323Y-C	1967-72 C10 with LS, 1-7/8" primary tube, pair	\$677.00
THY-324Y-C	1967-72 C10 with LS, 1-5/8" primary tube, pair	\$643.00
69646	1963-72 SBC, Shorty, pair	\$490.00

RADIO DASH REPAIR PANEL

Fix that butchered-up radio hole with our quality dash patch panel. Correct contour and knob holes for an OEM look.



5559RRP	1955-59, each	\$35.00
----------------	---------------	----------------



#6772LS1-FRK

Upgrading to LS?
See all of our
LS options on
page 256



#H8087-1

ENGINE INSTALL KITS FOR LS 1, LS 2, LS 3, & LS 6

Install a modern, dependable, light weight, low maintenance, high powered V8. Works with all Vortec and most LS engines. May not work with LSX heads, and dry sump oil systems. Kit includes: engine mounts perches, engine mount adapters, engine pads, full length ceramic coated headers, transmission crossmember and all mounting hardware and will work for your truck. *Note: These kits must also use Lokar dipstick #ED-5020 for 1997 and later car LS or #ED-5021 for 1999 and later truck LS engines.*

6366LS1-FRK	1963-66 C10, kit	\$869.00
6772LS1-FRK	1967-72 C10, kit	\$869.00
H8087-1	1973-87 C10 w/ LS conversion full length headers, pair	\$449.00

EDDIE MOTORSPORTS BILLET HOOD HINGES

Eddie Motorsports billet hood hinges are CNC machined to perfection. They are made of 6061-T6 billet aluminum and utilize sealed bearings for smooth and long lasting operation. These hood hinges are a great value without sacrificing quality. Available in a machined, polished or powdercoated custom color fusion-coated finish. Sold in pairs. Kits come standard with 360 lb. struts. 400 lb. also available if needed. *Note:*

Extreme cold may affect strut performance. These hinges will not allow you to lift hood up as high as factory.



Custom powdercoated colors available:



EMS149-22M	1955-57, Machined	\$570.00	EMS149-23CC	1967-72, Custom Color (specify)	\$665.00
EMS149-22P	1955-57, Polished	\$625.00	EMS149-24M	1973-80, Machined	\$570.00
EMS149-22CC	1955-57, Custom Color (specify)	\$665.00	EMS149-24P	1973-80, Polished	\$625.00
EMS149-23M	1967-72, Machined	\$570.00	EMS149-24CC	1973-80, Custom Color (specify)	\$665.00
EMS149-23P	1967-72, Polished	\$625.00			

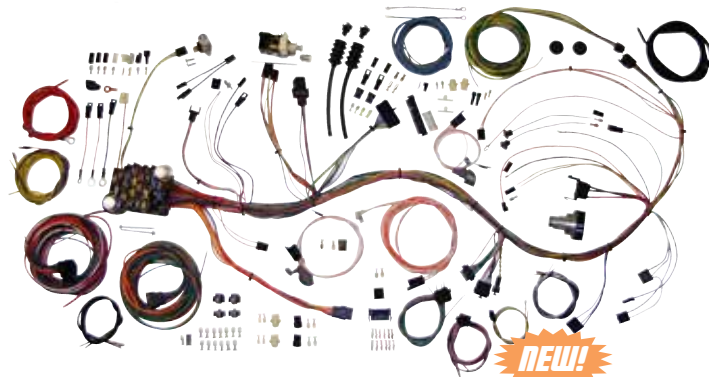

AMERICAN AUTOWIRE CLASSIC UPDATE SERIES WIRING KIT

Classic Update complete wiring kits are made for the automotive enthusiast who wants some modern amenities in their classic vehicle. These kits include everything you need to modernize your classic vehicle: Headlight, dimmer, and ignition switches; boots, tubes and grommets; fuses, relays, and flashers; original connectors, terminals, and disconnects. Classic update wiring systems are made for specific make/model/year vehicles and are currently available in 27 kits. *Note: These kits are designed for MODIFIED original vehicles, not OEM restoration projects.*



500467	1947-55 (1st Series 1955), kit	\$549.00
500481	1955-59 (2nd Series 1955), kit	\$549.00
500560	1960-66, kit	\$549.00
510333	1967-68, kit	\$589.00
510089	1969-72, kit	\$549.00
510347	1973-82, kit	\$636.00

STEALTH TAILGATE LATCHES

These cool tailgate latches install into the top of the tailgate so you can eliminate those unsightly tailgate chains. These latches rely on spring loaded pins to securely lock your tailgate in position. Available in stainless steel or plain steel. *Helpful "How-To" available at www.classicperform.com*



CPSLK-S1	1947-66, stainless steel, kit	\$59.00
-----------------	-------------------------------	----------------

EDDIE MOTORSPORTS BILLET HOOD LATCHES

Eddie Motorsports latest piece of custom hardware is their billet hood latch assemblies. Machined from solid chunks of 6061-T6 aluminum and 304 stainless steel, the latch assembly is a direct replacement for your cheap stock stamped steel pieces. The hood latch kit comes complete with a billet aluminum base plate, pilot bolt and retaining cup and pop-up spring (some applications). Stainless steel fasteners and billet aluminum finishing washers are also included. Available with a raw machined or highly polished finish as well as in a variety of Fusioncoated colors (see above).



MS276-05M	1967-72, Machined	\$89.00
MS276-05P	1967-72, Polished	\$95.00
MS276-05CC	1967-72, Custom Color (specify)	\$105.00



HIDDEN TOW HITCH

Hides unsightly platform hitch out of sight behind license plate. Positions hitch receiver behind license plate. Complete with hardware. *Note: For use with stock bumper, will not work with roll pans. Will not fit rear leaf spring trucks.*

6772HTH	1967-72, Hidden Hitch, each	\$245.00
6772HTH-K	1967-72, w/ License Plate Bracket, kit	\$275.00
6772LPB	1967-72, License Plate Bracket only, each	\$39.00