

# [POWER COMMANDER V]

**2012-2013 Kawasaki ZX-14R**

**Installation Instructions**



## **PARTS LIST**

- 1 Power Commander
- 1 USB Cable
- 1 CD-ROM
- 1 Installation Guide
- 2 Power Commander Decals
- 2 Dynojet Decals
- 2 Velcro
- 1 Alcohol swab
- 1 Posi-tap
- 3 Zip-ties

**THE IGNITION MUST BE TURNED  
OFF BEFORE INSTALLATION!**

YOU CAN ALSO DOWNLOAD THE  
POWER COMMANDER SOFTWARE AND  
LATEST MAPS FROM OUR WEB SITE AT:  
[www.powercommander.com](http://www.powercommander.com)

**PLEASE READ ALL DIRECTIONS BEFORE STARTING INSTALLATION**

**Dynojet**

2191 Mendenhall Drive North Las Vegas, NV 89081 (800) 992-4993 [www.powercommander.com](http://www.powercommander.com)

# POWER COMMANDER V INPUT ACCESSORY GUIDE

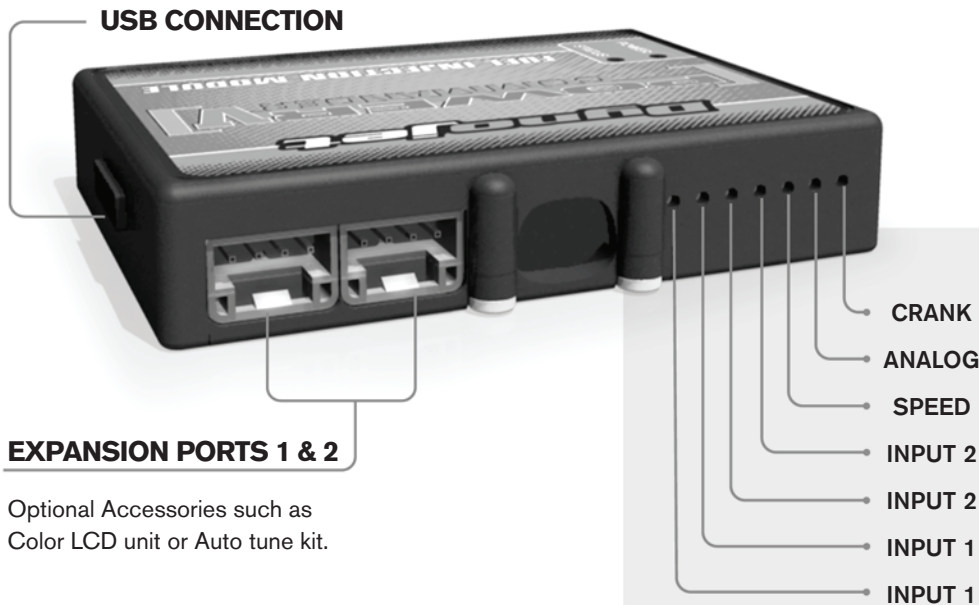

Optional Accessories such as  
Color LCD unit or Auto tune kit.

## Wire connections:

To input wires into the PCV first remove the rubber plug on the backside of the unit and loosen the screw for the corresponding input. Using a 22-24 gauge wire strip about 10mm from its end. Push the wire into the hole of the PCV until it stops and then tighten the screw. Make sure to reinstall the rubber plug.

NOTE: If you tin the wires with solder it will make inserting them easier.

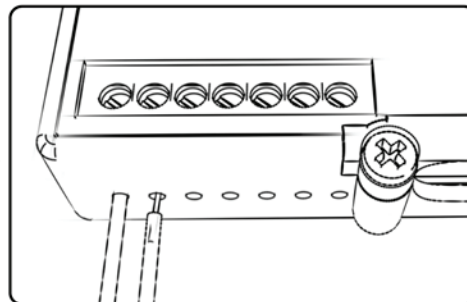

## ACCESSORY INPUTS

### Map -

(Input 1 or 2) The PCV has the ability to hold 2 different base maps. You can switch on the fly between these two base maps when you hook up a switch to the MAP inputs. You can use any open/close type switch. The polarity of the wires is not important. When using the Autotune kit one position will hold a base map and the other position will let you activate the learning mode. When the switch is "CLOSED" Autotune will be activated.

### Shifter-

(Input 1 or 2) These inputs are for use with the Dynojet quickshifter. Insert the wires from the Dynojet quickshifter into the SHIFTER inputs. The polarity of the wires is not important.

### Speed-

If your application has a speed sensor then you can tap into the signal side of the sensor and run a wire into this input. This will allow you to calculate gear position in the Control Center Software. Once gear position is setup you can alter your map based on gear position and setup gear dependent kill times when using a quickshifter.

### Analog-

This input is for a 0-5v signal such as engine temp, boost, etc. Once this input is established you can alter your fuel curve based on this input in the control center software.

### Crank-

Do **NOT** connect anything to this port unless instructed to do so by Dynojet. It is used to transfer crank trigger data from one module to another.

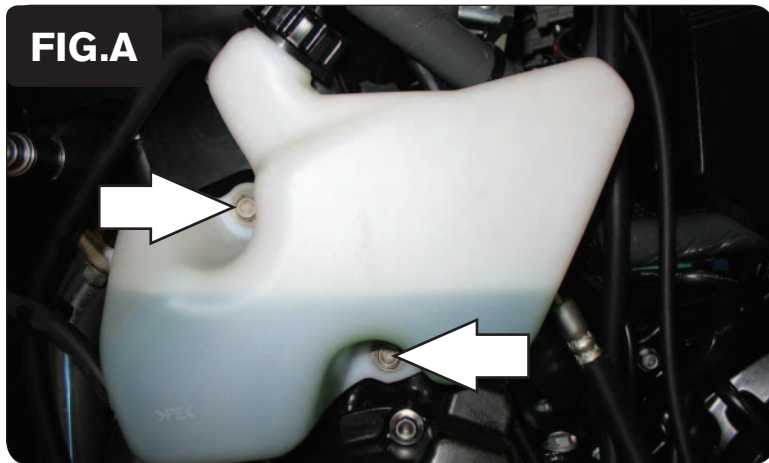

- 1 Remove the left and right side fairings, both inner fairings, the upper fuel tank cover, and ram air duct covers on both sides.
- 2 Remove the bolts that hold the coolant reserve bottle to the engine (Fig. A).  
*Let the bottle hang out of the way temporarily.*

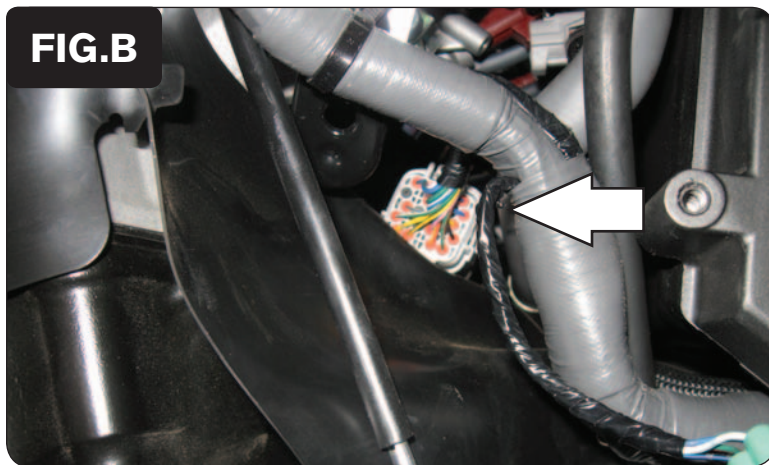

- 3 Disconnect the stock wiring harness from the throttle body harness (Fig. B).  
*These connectors are GREY in color and are located under the throttle bodies.*

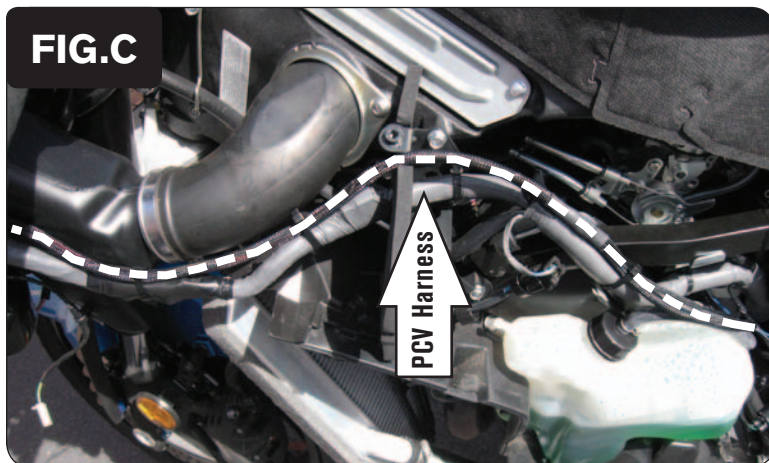

- 4 Lay the PCV next to the gauge panel temporarily and route the PCV harness along the stock wiring harness on the left side of the bike to the throttle body connection (Fig. C).  
*Use the supplied zip-ties to secure the PCV wiring harness to the stock wiring harness.*





- 5 Connect the PCV in-line of the stock wiring harness and throttle body harness (Fig. D).

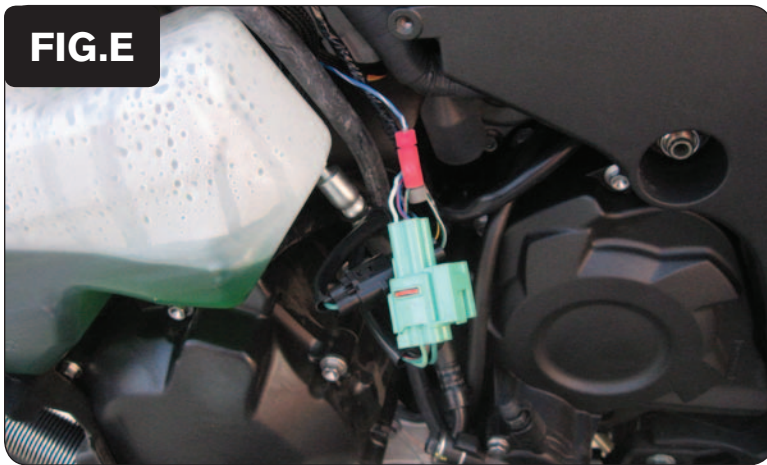

- 6 Use the supplied Posi-tap to attach the BLUE/WHITE wire from the PCV to the GREEN/RED wire of the stock gear position sensor (Fig. E).

*This GREEN 4 pin connector is located on the left side of the bike near the front sprocket cover.*

- 7 Route the remainder of the PCV wiring harness with the 2 pin crank connectors and ground lug under the throttle bodies to the right side of the bike.

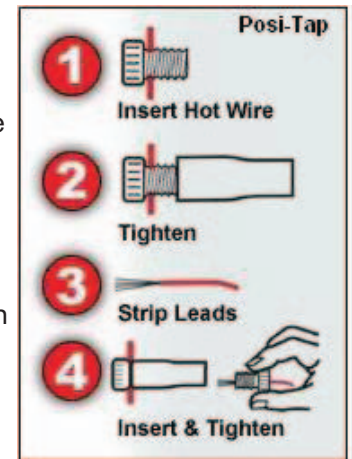

- 8 Locate and unplug the bike's Crank Position Sensor connectors.

*This is a BLACK 2 pin connector under the #3 throttle body, that is taped to the throttle body wiring harness. You can trace the wiring harness coming out of the right hand side flywheel cover to this connector (Fig. F).*



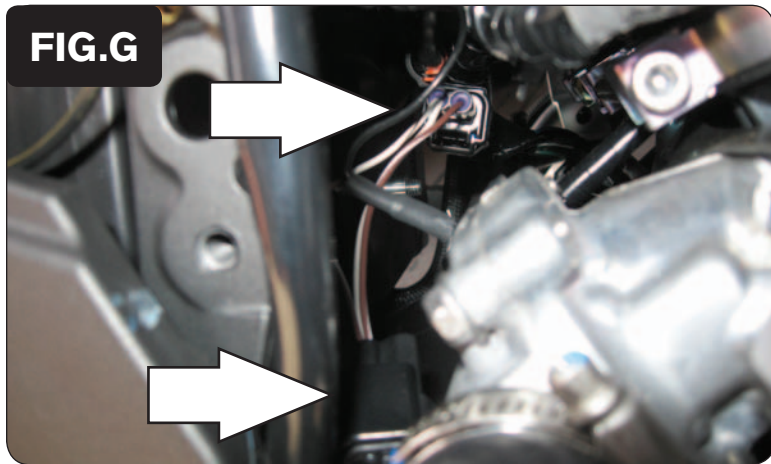

- 9 Plug the PCV wiring harness in-line of the stock Crank Position Sensor connectors (Fig. G).

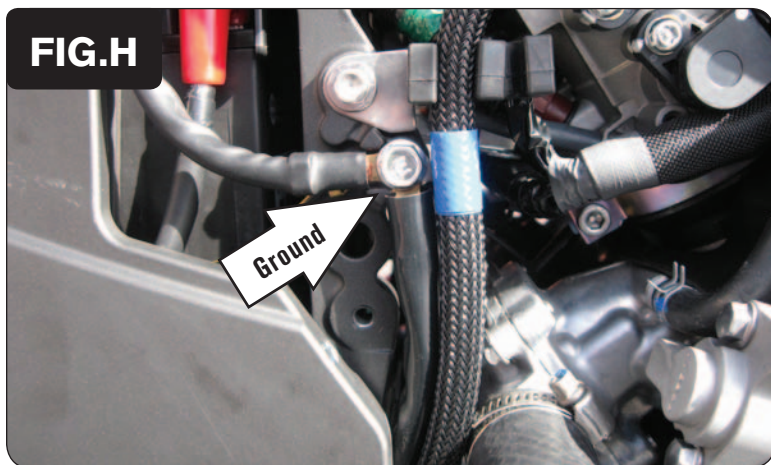

- 10 Secure the PCV ground wire with the eyelet to the stock ground bolt on the right hand side of the bike (Fig. H).
- 11 Reinstall the coolant reserve bottle.



- 12 Install the PCV module to the left hand ram air duct. Use the supplied velcro to secure the PCV module (Fig. I).

*Clean both surfaces with the supplied alcohol swab prior to applying the velcro.*

- 13 Reinstall the body panels.

*This bike uses a servo to hold the throttle plate open during cold starts. If the throttle position needs to be reset, make sure the bike is running at normal operating temperature before resetting the throttle position in the PCV software.*

**Temperature input location** - ORANGE wire of temperature connector on back of cylinder #3

**12v source for Auto-tune** - BROWN/YELLOW wire of BLACK 10 pin connector, located under LH ram air duct (near PCV install)